

#021620, 021621, 021622

Installation Instructions

2001-2007 Chevy/GMC 2500 HD 4wd 6" Suspension System



READ AND UNDERSTAND ALL INSTRUCTIONS AND WARNINGS PRIOR TO INSTALLATION OF SYSTEM AND OPERATION OF VEHICLE.

SAFETY WARNING

BDS Suspension Co. recommends this system be installed by a professional technician. In addition to these instructions, professional knowledge of disassembly/ reassembly procedures and post installation checks must be known.

PRODUCT SAFETY WARNING

Certain BDS Suspension products are intended to improve off-road performance. Modifying your vehicle for off-road use may result in the vehicle handling differently than a factory equipped vehicle. Extreme care must be used to prevent loss of control or vehicle rollover. Failure to drive your modified vehicle safely may result in serious injury or death. BDS Suspension Co. does not recommend the combined use of suspension lifts, body lifts, or other lifting devices.

You should never operate your modified vehicle under the influence of alcohol or drugs. Always drive your modified vehicle at reduced speeds to ensure your ability to control your vehicle under all driving conditions. Always wear your seat belt.

PRE-INSTALLATION NOTES

1. Special literature required: OE Service Manual for model/year of vehicle. Refer to manual for proper disassembly/reassembly procedures of OE and related components.
2. Adhere to recommendations when replacement fasteners, retainers and keepers are called out in the OE manual.
3. Larger rim and tire combinations may increase leverage on suspension, steering, and related components. When selecting combinations larger than OE, consider the additional stress you could be inducing on the OE and related components.

4. Post suspension system vehicles may experience drive line vibrations. Angles may require tuning, slider on shaft may require replacement, shafts may need to be lengthened or trued, and U-joints may need to be replaced.
5. Secure and properly block vehicle prior to installation of BDS Suspension components. Always wear safety glasses when using power tools.
6. If installation is to be performed without a hoist, BDS Suspension Co. recommends rear alterations first.
7. Due to payload options and initial ride height variances, the amount of lift is a base figure. Final ride height dimensions may vary in accordance to original vehicle attitude. Always measure the attitude prior to beginning installation.

POST-INSTALLATION WARNINGS

1. Check all fasteners for proper torque. Check to ensure for adequate clearance between all rotating, mobile, fixed, and heated members. Verify clearance between exhaust and brake lines, fuel lines, fuel tank, floor boards and wiring harness. Check steering gear for clearance. Test and inspect brake system.
2. Perform steering sweep to ensure front brake hoses have adequate slack and do not contact any rotating, mobile or heated members. Inspect rear brake hoses at full extension for adequate slack. Failure to perform hose check/ replacement may result in component failure. Longer replacement hoses, if needed can be purchased from a local parts supplier.
3. Perform head light check and adjustment.
4. Re-torque all fasteners after 500 miles. Always inspect fasteners and components during routine servicing.

**102 S. Michigan Avenue • Coldwater, MI 49036
517-279-2135 • www.bds-suspension.com**

Parts List

Part #	Qty	Description
01178	1	Steering Knuckle- DRV
01179	1	Steering Knuckle- PASS
539	1	Bolt Pack
540	1	Bolt Pack
541	1	Bolt Pack
542	1	Bolt Pack
01180	1	Front Crossmember
01181	1	Rear Crossmember
M02096-RB	2	Bump Stop
01183	2	CV Spacer
01184	1	Differential Skid Plate
01185	1	Differential Drop Bracket (DRV)
01186	1	Differential Drop Bracket (PASS)
01187	1	Weld-in Plate
01188	2	Compression Strut
01189	2	Compression Strut Mount
01190	2	Strut Mount Nut Tab
01191	2	Torsion Bar Drop Bracket
01192	1	Carrier Bearing Drop Bracket
01196	2	Rear Bump Stop Spacers
01661	1	Brake Line Bracket
2081BK	8	Bushing
32-1	4	5/8" x 0.083" x 2.365" Sleeve
BSJRFB	2	Bushing
15-1	1	3/4" x 0.083" x 2.955" Sleeve
02129	4	U-Bracket
911104	2	Sway Bar Link
SB58RB	4	Bushing
45313	4	Sleeve
BSC075	4	Bushing
44-1	2	Sleeve
SBLA	1	Brake Line Bracket
	2	Loctite®

BOLT PACK 539

Qty	Description
2	5/8"-11 x 6" bolt
2	5/8"-11 x 5" bolt
4	5/8"-11 prevailing torque nut
8	5/8" SAE flat washer
1	9/16"-12 x 4-1/2" bolt
3	9/16"-12 prevailing torque nut
6	9/16" SAE flat washer
2	9/16"-12 x 1-1/2" bolt
5	10mm-1.50 x 60mm bolt
5	10mm flat washer
2	3/8"-16 standard hex nut
2	3/8" SAE flat washer
2	3/8" lock washer

BOLT PACK 540

Qty	Description
3	1/2"-13 x 1-1/4" bolt
3	1/2" SAE flat washer
12	10mm-1.50 x 70mm bolt
12	10mm flat washer
6	1/4"-20 x 3/4" bolt
6	1/4" SAE flat washer
6	1/4" lock washer
4	7/16"-14 x 3-1/2" bolt
4	7/16"-14 x 1-1/4" bolt
4	7/16"-14 prevailing torque nut
12	7/16" SAE flat washer
6	Wire Clamp

BOLT PACK 541

Qty	Description
8	7/16"-14 x 1-1/4" bolt
8	7/16"-14 prevailing torque nut
16	7/16" SAE flat washer
4	3/8"-16 x 1-1/2" bolt
4	3/8"-16 prevailing torque nut
8	3/8" SAE flat washer
2	3/8"-16 x 2" bolt
2	3/8"-16 prevailing torque nut
4	3/8" SAE flat washer
1	5/16"-18 x 1" bolt
1	5/16"-18 prevailing torque nut
2	5/16" USS flat washer
1	3/8"-16 x 1" bolt
1	3/8"-16 prevailing torque nut
2	3/8" USS flat washer

BOLT PACK 556

Qty	Description
4	5/8" SAE flat washer
4	5/8"-11 prevailing torque nut
4	3/8"-16 x 2-1/2" bolt
4	3/8"-16 prevailing torque nut
8	3/8" SAE flat washer

PRE-INSTALLATION MEASUREMENTS

Measure from the center of the wheel up to the bottom edge of the wheel opening

LF _____ RF _____ LR _____ RR _____

FRONT INSTALLATION

1. Park the vehicle on a clean, level surface and block the rear wheels for safety.
2. Safely raise the front of vehicle and support with jack stands for safety.
3. Remove the wheels.
4. Measure and record the length of the exposed thread on the torsion bar adjusting bolts for later reference.
DRV _____ PASS _____
5. Remove the torsion bar assembly. **CAUTION:** The torsion bar is under extreme pressure. Use the correct unloading tool to remove the pressure on the torsion bars before attempting to remove the assembly. A J36202 or equivalent torsion bar unloading tool must be used. Be sure to follow the OE manual and the torsion bar unloading tool literature as to how to unload the torsion bars.
6. Unload the torsion bars, but do not remove.
7. Mark the unloaded torsion bars to indicate passenger's and driver's side. Mark both of the torsion bars to indicate the front versus the rear for later installation. Also mark the torsion bars relative to the control arms at the front to note indexing. Mark the rear of the bars relative to the adjusting arms to indicate indexing.
8. Drive the torsion bars forward using a maul or an air hammer through the access hole in the back of the torsion bar crossmember. Note: This will allow the torsion bar adjusters to drop free.
9. Remove the bolts holding the torsion bar crossmember to the frame. Retain these fasteners with the crossmember after removal. Remove the crossmember. Note: It may be necessary to remove a portion of the exhaust system on some vehicles in order to complete this operation.
10. Remove the torsion bars by pulling them toward the rear of the vehicle.
11. Remove the front OE differential skid plate and front splash shield from the vehicle. These will not be reused.
12. Remove the sway bar end links from the sway bar and lower control arms. Discard the end links.
13. Remove the shocks. Discard the shocks and retain the lower mounting hardware.
14. Disconnect the tie rod ends from the steering knuckles. Remove and retain the mounting nuts. Strike the steering knuckle at the tie rod end to dislodge the end (Fig 1). Take care not to damage the tie rod end.

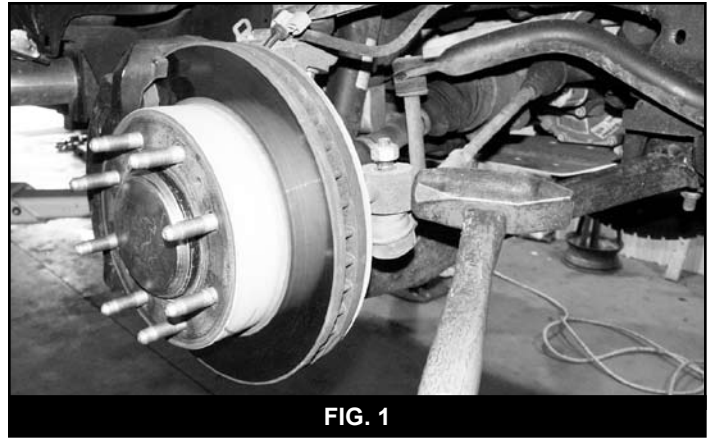

FIG. 1

15. Disconnect the ABS brake wire from the frame and the control arm. Remove the brake hose bracket from the steering knuckle (Fig 2).
16. Follow the ABS line up to the frame to find the wire connector. Disconnect the ABS wire and hang it out of the way.
17. Disconnect the brake line bracket from the upper control arm by removing the retaining bolt (Fig 2). Retain the mounting hardware.

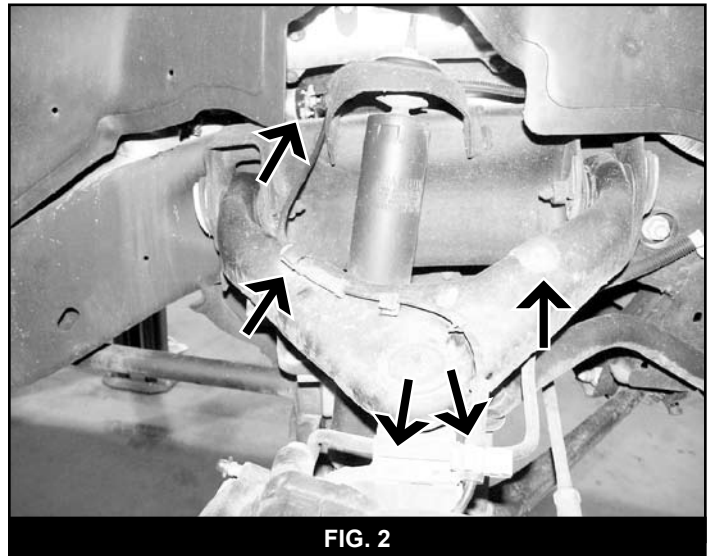

FIG. 2

18. Remove the brake caliper anchor bracket bolts and pull the caliper free from the steering knuckle and rotor (Fig 3). Hang the caliper securely out of the way. Retain caliper mounting hardware. Remove the brake rotor from the hub. Note: Do not allow the brake caliper to hang from the brake hose.

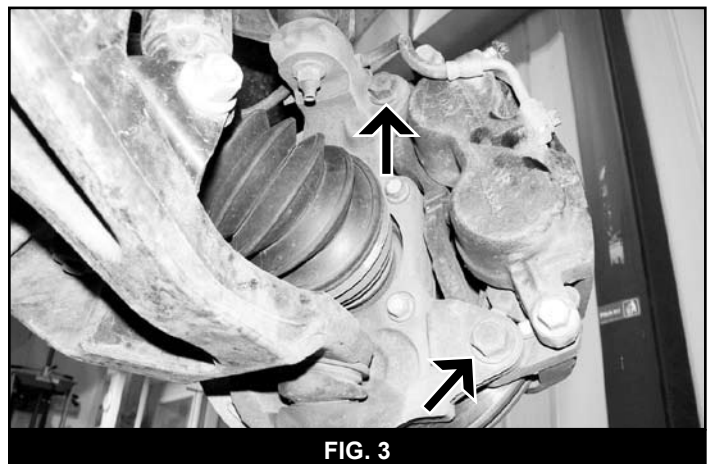
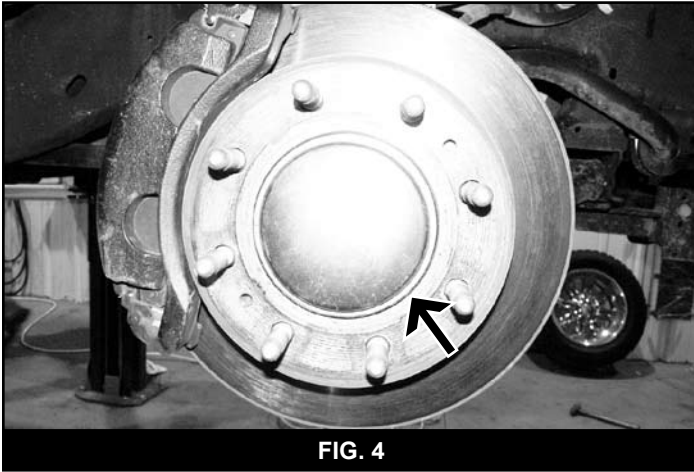
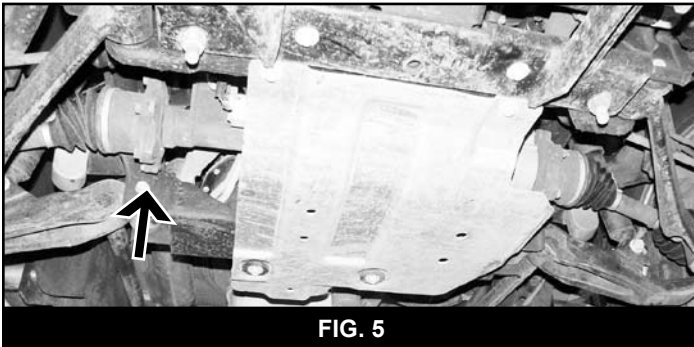

FIG. 3

19. Carefully remove the axle hub dust cover, if equipped. (Fig 4). Remove the axle hub nut.



20. Disconnect the CV axles from the differential by removing the mounting flange bolts (Fig 5).



21. Remove the upper and lower ball joint nuts. Reinstall the nuts a few turns by hand. Dislodge the upper and lower ball joints from the steering knuckle by striking the knuckle near each joint with a hammer. Remove the upper ball joint nut and allow the knuckle/CV axle and lower control arm to swing down. Remove the CV axle from hub.
22. Remove the lower ball joint nut and remove the knuckle from the lower control arm. Retain the ball joint nuts.
23. Remove the four bolts mounting the hub bearing assembly to the OE steering knuckle. Retain the mounting bolts. Remove the hub assembly from the knuckle. Note: It may be necessary to press the hub out of the knuckle as a result of excessive corrosion on some vehicles.
24. Carefully remove the large O-ring from the knuckle and retain.
25. Install the large OE hub o-rings in the new knuckles (01178, 01179). Install the corresponding hub and fasten with the stock mounting bolts. Index the hub so that the ABS line runs out the front side of the knuckle under the steering arm. Use loctite on the bolt threads and torque to 125 ft-lbs. **Note:** The OE dust shield will not be reused.
26. Remove the lower control arm pivot bolts and remove the control arm from the vehicle.
27. Remove the OE lower control arm bump stops from the frame.
28. Disconnect the front driveshaft from the differential housing and retain all mounting hardware.
29. Disconnect the vacuum line from the driver's side of the front differential. Disconnect the electrical connector from the differential actuator and remove the wire from the two plastic clamps along the top of the differential (Fig 6, 7).

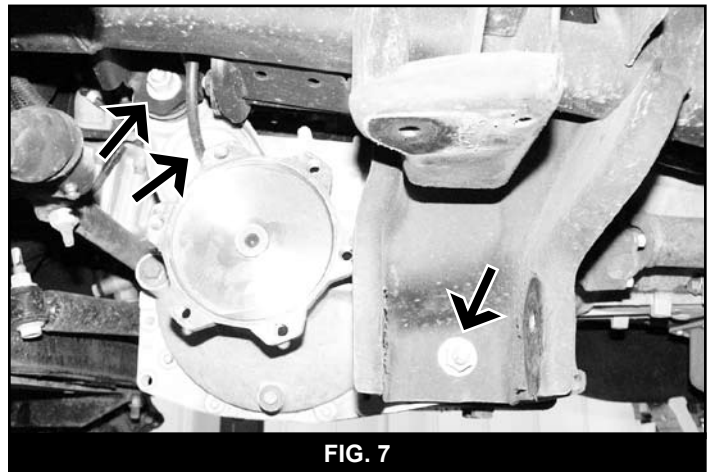
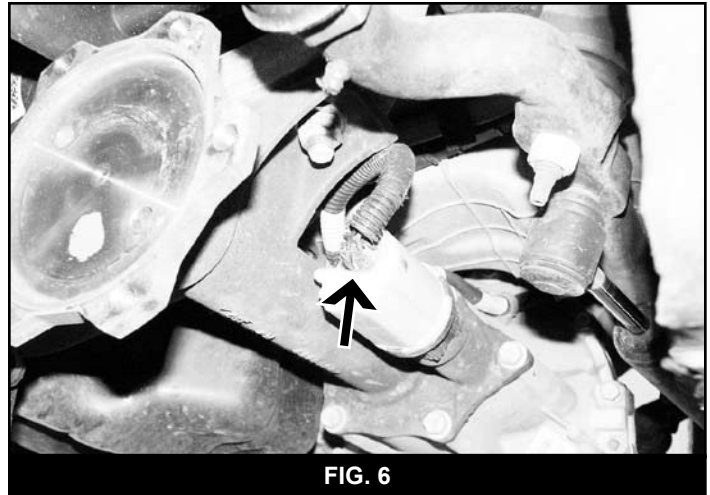

30. Remove the stock rear differential crossmember by removing the two mounting bolts on each side (Fig 8).

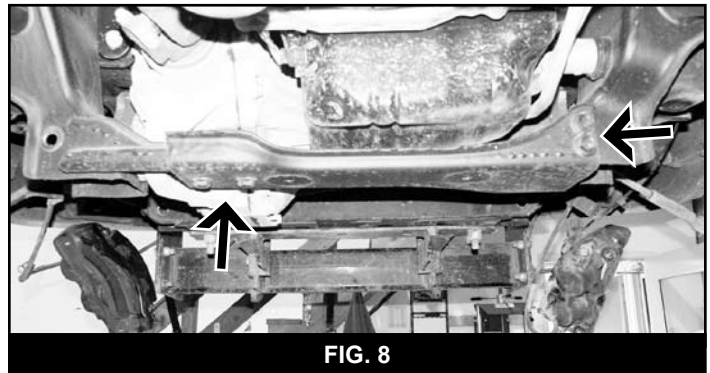

31. Support the front differential with an appropriate jack and remove the driver's side front and rear mounting bolts as well as the two mounting nuts on the passenger's side (Fig 7, 9). Retain all hardware. To gain additional clearance for removal, pull the steering all the way to the left. Remove the differential from the vehicle. Note: On some diesel equipped vehicles it may be easier to remove the differential if the next step is completed first.

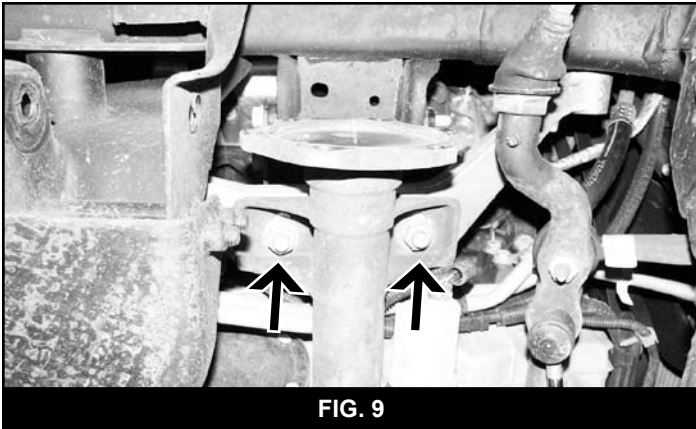

FIG. 9

32. The driver's side rear differential mount must be removed. Measure from the backside of the control arm pocket 1-3/4" and make a vertical cut line around the entire pocket (Fig 10A, 10B). Using a sawzall, die grinder or plasma cutter, remove the differential mount from the frame. Note: Always check for fuel lines and/or electrical wires before cutting. Undercoating is flammable. Keep a fire extinguisher close by for safety.

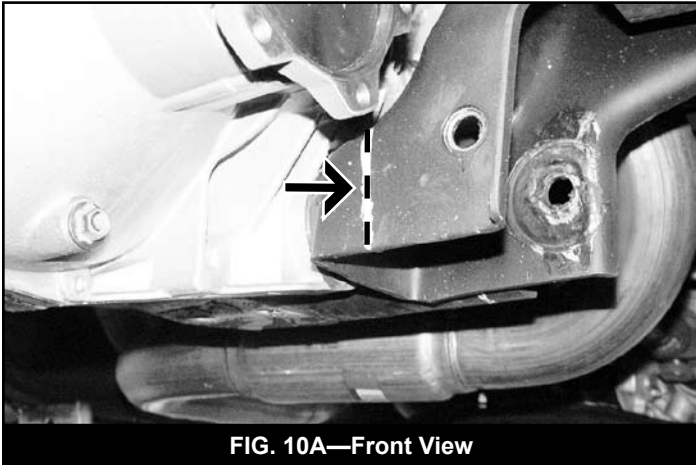

FIG. 10A—Front View

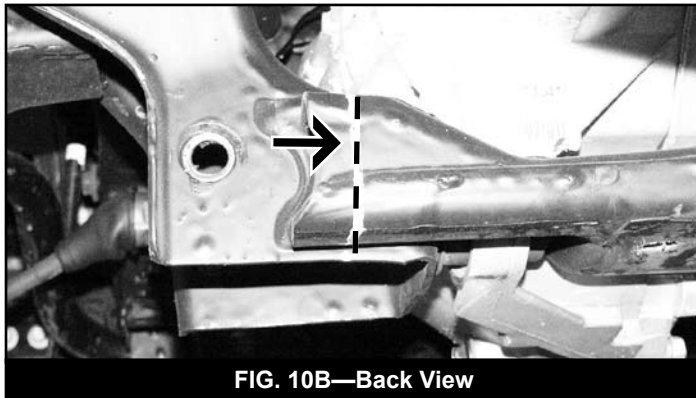

FIG. 10B—Back View

33. With the back of the control arm pocket removed, clean the area free of paint and grease. Place the provided plate up to the back of the pocket and weld in place. Let the area cool and coat with a rust preventative paint or undercoating. Undercoating is flammable. Keep a fire extinguisher close by for safety. Welding should be performed by a certified welder.

34. The front driver's side differential mounting eye must be removed from the differential (Fig 11). Mark the eye with a cut line smooth to the housing. Using a sawzall, cut the mounting eye off of the housing. Do not cut into the main housing body.



FIG. 11

35. Install the bushings (3624RB) and 3/4" x 2.955" sleeve (15-1) in the new differential bracket (01185). Line the bracket up to the differential case bolts to determine which five bolts to remove. Remove the appropriate bolts and install the bracket with five 10mm x 60mm bolts and 10mm flat washers from bolt pack #539 (Fig 12A). Use Loctite on the threads and torque to 30 ft-lbs. **Note:** On 2007 models, trim the small boss sticking out from the differential housing between the two lower brackets mounting holes. Trim the boss just enough to clear the bracket so it can mount flush. (Fig 12B)

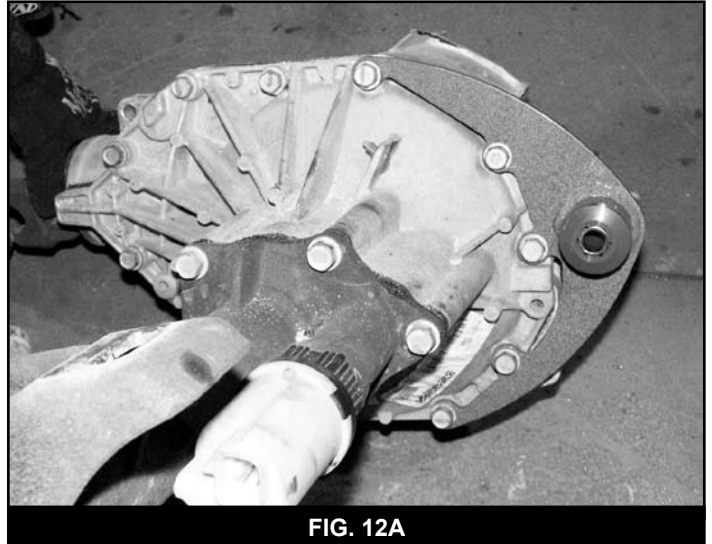

FIG. 12A



FIG. 12B

36. Install the provided bump stops to the new BDS rear crossmember with 3/8" nuts, lock washers and 3/8" SAE flat washers from bolt pack #539. Tighten hardware securely (Fig 13).

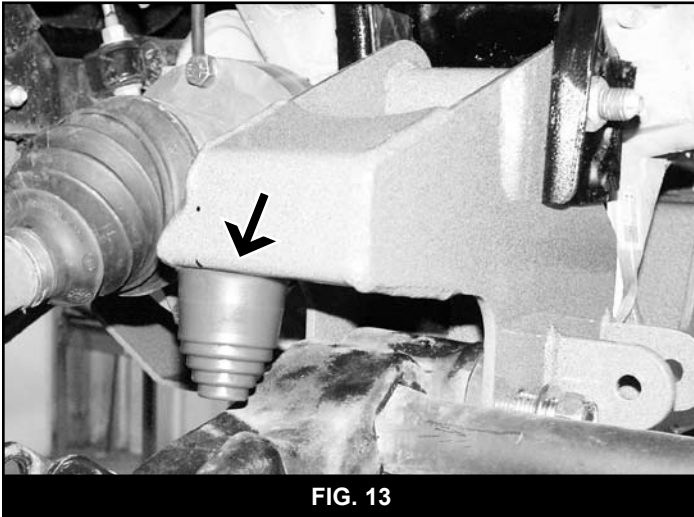

FIG. 13

Crossmember Installation Notes: BDS crossmembers have slotted mounting holes to ease installation and compensate for any variances in OE frame bracket locations. Once the crossmembers are installed, visually center the crossmembers in the frame before the mounting bolts are tightened. Before installing either crossmember, be sure that the inside surfaces of the OE lower control arm pockets are free of burrs. Commonly, the OE bolts and washers stretch the mounting holes when installed and leave a rolled edge that could hinder the installation of the new crossmembers. These edges can be smoothed with a file or rotary grinding tool.

37. Install the new rear crossmember (01181) in the lower rear OE control arm pockets using the original control arm pivot bolts, nuts and washers. The bolt heads must be to the front of the vehicle. Leave mounting bolts loose.
38. Install the provided passenger's side differential bracket (01186) to the OE differential mounting studs and retain with the original nuts and washers (Fig 14). Leave hardware loose. The wide end of the bracket goes to the front and the open side faces inward.
39. Install the differential in the new rear crossmember and fasten with the OE hardware. Leave hardware loose.
40. Fasten the passenger's side of the differential to the new bracket with two 9/16" x 1-1/2" bolts, nuts and 9/16" SAE washer from bolt pack #539. Snug hardware.
41. Install the new front crossmember (01180) in the lower front OE control arm pockets using the original control arm pivot bolts, nuts and washers. When install the crossmember, align the front differential in the tabs on the back of the crossmember (Fig 14). Leave mounting hardware loose.

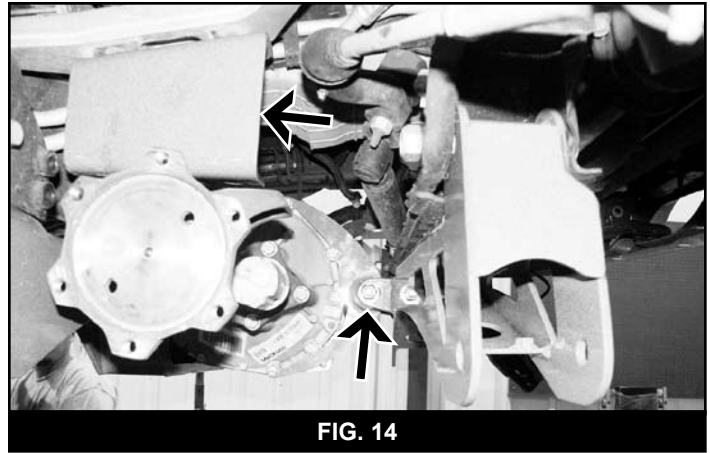

FIG. 14

42. Fasten the front differential mount to the front crossmember with a 9/16" x 4-1/2" bolt, nut and 9/16" SAE washers from bolt pack #539. Leave hardware loose.
43. Reconnect the electrical wires and breather hose to the differential. It may be necessary to gain slack for the breather hose up in the engine compartment.
44. Install the new differential skid plate (01184) to the welded nuts on the front and rear crossmembers with 1/2" x 1-1/4" bolts and 1/2" SAE washers from bolt pack #540 (Fig 15). Use loctite on the bolt threads. Leave hardware loose.
45. Install the OE lower control arms in the front and rear crossmembers with 5/8" x 5" bolts (front), 5/8" x 6" bolts (rear), nuts and 5/8" SAE washers from bolt pack #539. Leave hardware loose. The heads of the bolts must be to the front of the vehicle.
46. Tighten the following hardware:
- Front and rear crossmember pocket bolts to 100 ft-lbs
 - Driver's side differential bolts to 70 ft-lbs
 - Passenger's side differential bolts and nuts to 70 ft-lbs
 - Differential skid plate bolts to 50 ft-lbs.

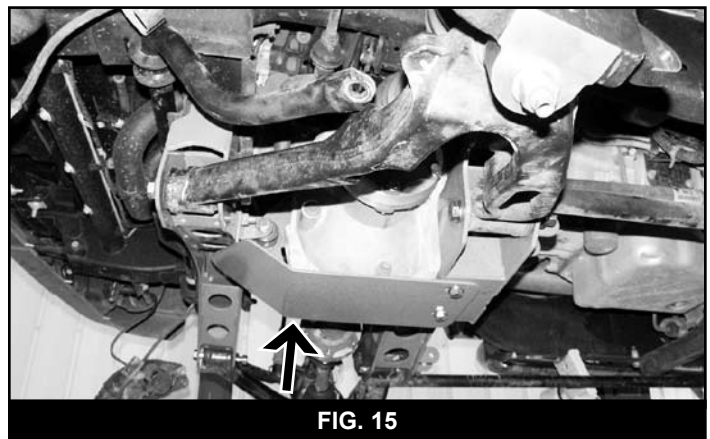

FIG. 15

47. Attach the new knuckle assembly to the upper and lower ball joints and fasten with the OE nuts. Torque the upper ball joint to 37 ft-lbs and the lower to 74 ft-lbs.
48. Rotate the steering tie rod 180° and install it in the new knuckle steering arm from the top down. Fasten with the OE nut and torque to 30 ft-lbs.
49. Install the CV axles in the hubs and fasten with the OE axle nut. Be sure that the axle is fully seated in the hub and torque the axle nut to 155 ft-lbs. Install the axle nut cover if equipped.

50. Install the provided CV shaft spacers (01183) between the CV shaft and the differential. Fasten the CV shaft and spacers to the differential with 10mm x 70mm bolts and 10mm flat washers from bolt pack #540 (Fig 16). Use loctite on the bolt threads and torque them to 58 ft-lbs in a crossing pattern.

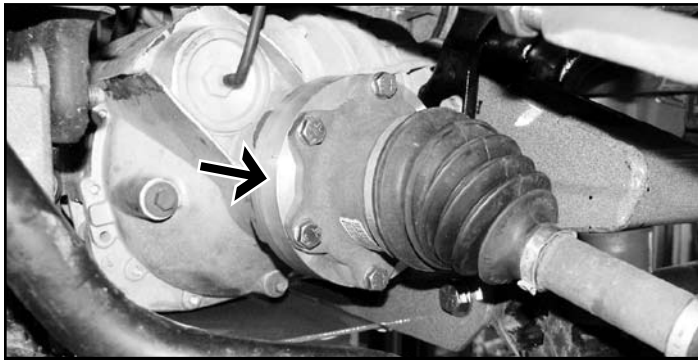

FIG. 16

51. Install the brake rotor on the hub then install the brake caliper on the rotor/knuckle and fasten with the OE mounting bolts. Torque the caliper bolts to 70 ft-lbs. Be sure that the brake hose is routed behind the knuckle and under the upper control arm. Use Loctite® on caliper hardware.
52. Attach the brake hose to the upper control arm in the original location with the stock hardware. Attach the hose to the steering knuckle in the holes provide with a 1/4" x 3/4" bolt, 1/4" SAE flat washer and 1/4" lock washer from bolt pack #540. Torque to 10 ft-lbs. Note: The OE brake hose brackets can be spread open and slid along the hose as necessary.
53. Attach the ABS line to the front side of the knuckle with the provided wire clamps and 1/4" x 3/4" bolts, 1/4" SAE flat washers and 1/4" lock washers from bolt pack #540. Torque to 10 ft-lbs. Attach the ABS wire to the upper control arm with the provided wire ties and reconnect the wire connector at the frame. (Fig 17)

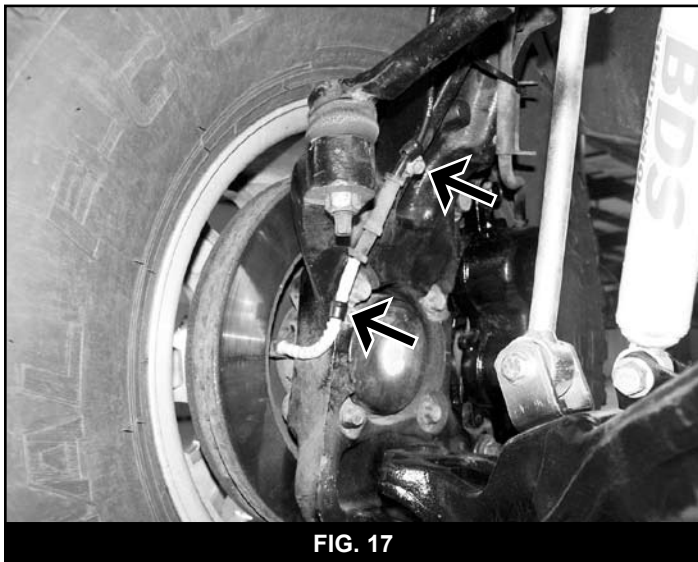

FIG. 17

54. Double check brake hoses and ABS wires for clearance of all moving objects. Do a steering sweep to check for clearances.
55. Install the new BDS shocks with the new upper hardware in conjunction with the OE lower mounting hardware. Torque the lower bolt to 35 ft-lbs and tighten the upper nuts until the bushings begin to swell.

56. Loosely install the provided sway bar link u-brackets (02129) to the link mounting holes in the sway bar and lower control arm with 5/8" bolts, nuts, and SAE washers from bolt pack #556. The SAE washers will mount on the head of the bolt inside of the u-bracket.
57. Install the provided hourglass bushings (3624RB) and sleeves (45313) in the eyes of the new sway bar end links (911104). Install the links in the u-bracket mounted on the lower control arms and sway bar. The links should be mounted so that the u-shape of all the brackets can be seen from the side of the vehicle. Retain the links in the brackets with 3/8" x 2-1/2" bolts, nuts and 3/8" SAE washers from bolt pack #556.
58. With the links completely installed, tighten the 3/8 hardware to 30 ft-lbs and the 7/16" hardware to 40 ft-lbs.
59. Attach the driveshaft to the differential with the original mounting hardware and torque to 19 ft-lbs.
60. Install the bushings (2081BK) and sleeves (32-1) in the new compression struts (01188). Attach the struts to the mounting tabs on the back of the rear crossmember with 7/16" x 3-1/2" bolts, nuts and 7/16" SAE flat washers from bolt pack #540. Leave hardware loose.
61. Swing a compression strut up to the rear crossmember to help determine the positioning of the rear mounting bracket. With Allison transmissions the hole in the mounting tab should be closer to the front (Fig 18- Allison Transmission Shown). On other transmissions the hole will be closer to the rear.

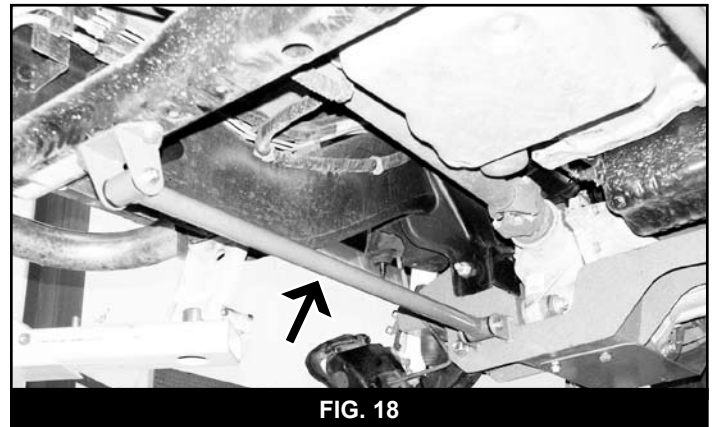

FIG. 18

62. After the position is determined, install the rear mounting bracket (01189) to the compression strut and swing it up to the transmission crossmember again. Ensure that the two mounting holes in the bracket are relatively centered on the crossmember and using the bracket as a template, mark the holes on the crossmember for drilling. Note: If the bracket is not lining up on the crossmember correctly, turn the bracket around on the strut. Some vehicles may have a transfer case skid plate mounting off of the transmission crossmember that may interfere with the rear strut mount. If this is the case remove the skid plate. It can either be modified to clear the new mount or left off.
63. Drill 7/16" holes at the marks on the transmission crossmember through the first layer of metal only.
64. Install the compression strut nut tab (01190) in the transmission crossmember and line the nuts up with the holes just drilled. Attach the compression strut mount to the crossmember with 7/16" x 1-1/4" bolts and 7/16" SAE flat washers from bolt pack #540. Use Loctite® on bolt threads. Torque bolts to 35 ft-lbs.

65. Install the driver's and passenger's side torsion bars in the front lower control arms using the index marks made earlier. Slide the bars forward about one foot.
66. Position the new torsion bar crossmember drop brackets (01191) on the frame directly below the original mount (A string with a weight on the end works well to help position the bracket). Clamp the bracket in place. Using the bracket as a template, mark the four mounting holes on the frame. Remove the bracket and drill a 7/16" hole at each mark. Check inside the frame rails before drilling for any lines or hoses that could be damaged. Note: Some models may have a emergency brake line cable guide that must be removed to bracket clearance. The ring can be relocated or just removed.
67. After drilling the holes, attach the brackets to the frame with 7/16" x 1-1/4" bolts, nuts and SAE flat washers from bolt pack #541 (Fig 19). Torque bolts to 35 ft-lbs.

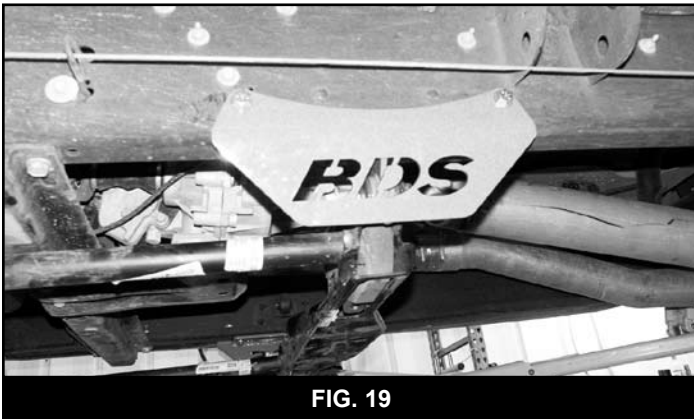

FIG. 19

68. Install the provided bushings (BSC075) and sleeves (44-1) in the new torsion bar drop brackets.
69. Install the torsion bar crossmember to the new drop bracket with the OE hardware and torque to 60 ft-lbs.
70. Install the driver's and passenger's torsion bars into the adjusters and crossmember using the index marks made earlier. Load the torsion bars with the appropriate tools and set adjuster bolts to the measurements made before disassembly. Do not adjust the torsion bars higher than 30" from the bottom of the fender to the center of the front hub with the vehicle setting on flat ground.
71. Install the front wheels and torque the lug nuts to the appropriate specifications. Spin the wheels and do a steering sweep to check for any binding or clearance issues.
72. Lower the vehicle to the ground and bounce it to settle the suspension. Torque the lower control arm bolts to 125 ft-lbs.
73. Double check all fasteners.

REAR INSTALLATION

74. Raise the rear of the vehicle and support the frame with jack stands just ahead of the spring hangers.
75. Remove the wheels.
76. Support the rear axle with a hydraulic jack under the differential and remove the OE shocks. Retain hardware.
77. Disconnect the brake line junction block from the differential by removing the differential cover bolt.
78. Install the provided brake line extension bracket to the original differential mounting location with the OE fastener and tighten securely.
79. Disconnect the emergency brake cable retainers from the driver's side frame rail. Retain all parts and hardware.

80. Disconnect the OE bump stops from the frame and retain the mounting nuts.
81. Install the provided bump stop brackets (01196) to the original bump stop mounting holes in the frame with 3/8" x 1-1/2" bolts, nuts and 3/8" SAE washers. Torque hardware to 30 ft-lbs. The open end of the bracket should face in and the end with three holes should face down.
82. Install the OE bump stop to the relocation brackets with the OE nuts and torque to 30 ft-lbs. Note: The bump stops have a locating tab that will fit into the middle hole in the relocation bracket (Fig 20).

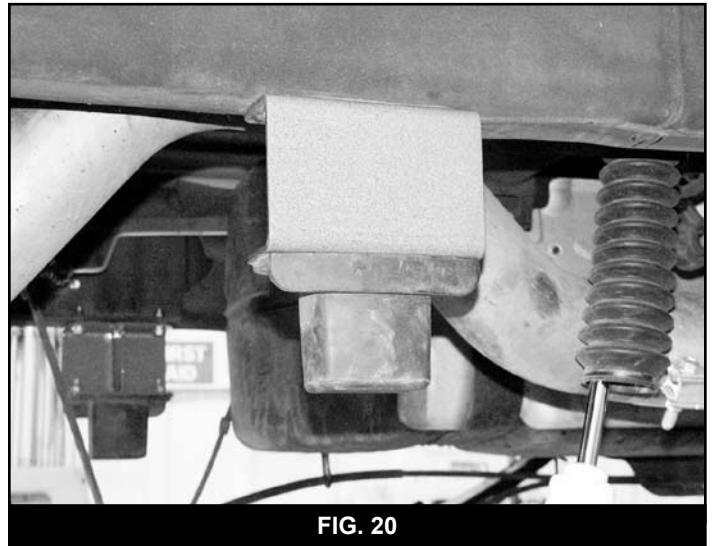

FIG. 20

83. While supporting the axle with a floor jack, remove the passenger's side u-bolts. Lower the axle from the spring.

LIFT BLOCK INSTALLATION

84. Lower the axle from the spring enough to install the 5" block. The short end of the block goes toward the front of the vehicle. Take care not to over-extend any brake lines. Note: It may be necessary to loosen the driver's side u-bolts to allow the axle to drop away from the passenger's side spring.
85. Align the pins/holes in the block, axle and spring and raise the axle. Install the provide u-bolts, nuts and washers and snug them to the axle. Final torque of the u-bolts will be done with the weight of the vehicle on the axle.
86. Repeat on driver's side of the vehicle.

SPRING INSTALLATION

87. Lower the axle from the spring. Remove the front spring hanger bolt and rear spring shackle-to-frame bolt and remove the spring from the vehicle.
88. Install the provide bushings and sleeves in the new BDS spring.
89. Remove the shackle from the OE spring and loosely install it on the corresponding end of the BDS spring.
90. Install the new spring in the vehicle with the OE mounting bolts and leave bolts loose.
91. Align the spring pin and the axle perch hole and raise the axle. Install the provided u-bolts and snug them to the axle. Final torque of the u-bolts will be done with the weight of the vehicle on the axle.
92. Repeat on driver's side of the vehicle. Note: The fuel tank may need to be moved to allow removal of the front hanger bolts.

SPRING AND BLOCK APPLICATIONS

93. Install the provided BDS shocks with the OE hardware.
94. Attach the brake junction block to the relocation bracket on differential with 5/16" x 1" bolt, nut and 5/16" USS washers from bolt pack #541 (Fig 21). Note: If more brake line slack is needed, the OE brake line bracket at the frame can be disconnected and relocated.

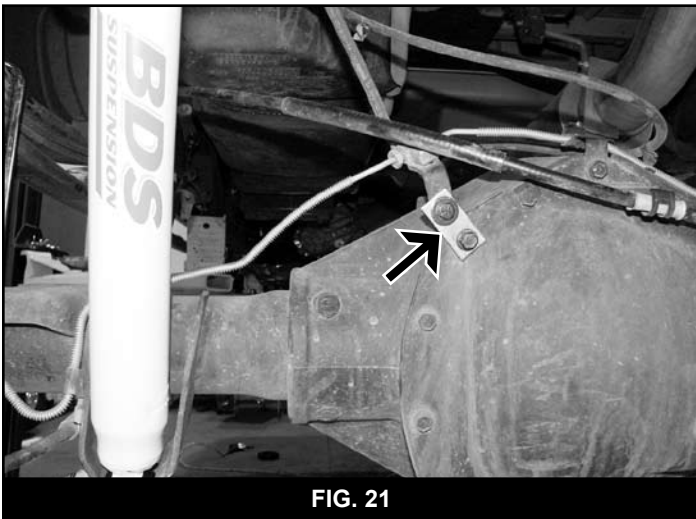

95. Install the provided 3" long brake line relocation bracket to the forward most emergency brake retainer mount with the OE hardware (Fig 22). Install the OE retainer to the bracket with a 3/8" x 1" bolt, nut and 3/8" USS washers.

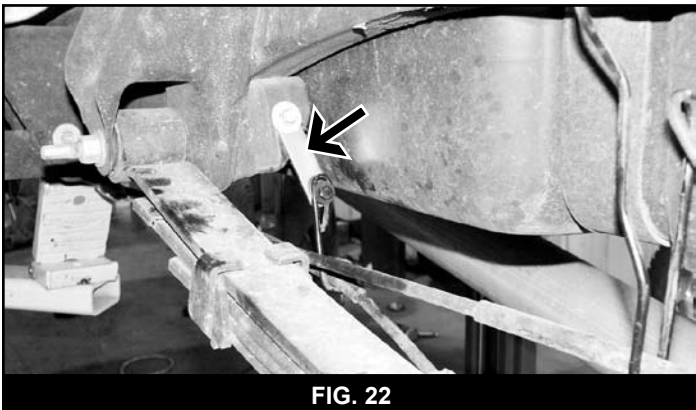

96. Install the rear retainer to the frame in the original hole. The lower emergency bracket line will need to be removed from the rear retainer.
97. If the vehicle is equipped with a two-piece driveshaft the carrier bearing must be relocated. Disconnect the carrier bearing mount from the frame crossmember.
98. Remove the OE studs from the bracket.
99. Install the provided carrier bearing drop bracket with 3/8" x 2" bolts, nuts and thru-hardened 3/8" SAE washers. Torque bolts to 30 ft-lbs.
100. Install the wheels and lower the vehicle to the ground.
101. Bounce the vehicle to settle the suspension and torque the u-bolts to 100-120 ft-lbs.
102. If the springs were replaced, torque the shackle and hanger bolts to 70 ft-lbs.
103. Double check all hardware.
104. Check all fasteners after 500 miles.
105. Adjust headlights.
106. A front end alignment must be performed.



102 S. Michigan Ave., Coldwater, MI 49036

Phone: 517-279-2135

Web/live chat: www.bds-suspension.com

E-mail: tech@bds-suspension.com

Part#: **021625**

Product: **6" Suspension System**

Application: **2001-2007 Chevy/GMC 2500 HD 4wd**

READ AND UNDERSTAND ALL INSTRUCTIONS AND WARNINGS PRIOR TO INSTALLATION OF SYSTEM AND OPERATION OF VEHICLE.

SAFETY WARNING BDS Suspension Co. recommends this system be installed by a professional technician. In addition to these instructions, professional knowledge of disassembly/ reassembly procedures and post installation checks must be known.

PRODUCT SAFETY WARNING Certain BDS Suspension products are intended to improve off-road performance. Modifying your vehicle for off-road use may result in the vehicle handling differently than a factory equipped vehicle. Extreme care must be used to prevent loss of control or vehicle rollover. Failure to drive your modified vehicle safely may result in serious injury or death. BDS Suspension Co. does not recommend the combined use of suspension lifts, body lifts, or other lifting devices.

You should never operate your modified vehicle under the influence of alcohol or drugs. Always drive your modified vehicle at reduced speeds to ensure your ability to control your vehicle under all driving conditions. Always wear your seat belt.

PRE-INSTALLATION NOTES

1. Special literature required: OE Service Manual for model/year of vehicle. Refer to manual for proper disassembly/ reassembly procedures of OE and related components.
2. Adhere to recommendations when replacement fasteners, retainers and keepers are called out in the OE manual.
3. Larger rim and tire combinations may increase leverage on suspension, steering, and related components. When selecting combinations larger than OE, consider the additional stress you could be inducing on the OE and related components.
4. Post suspension system vehicles may experience drive line vibrations. Angles may require tuning, slider on shaft may require replacement, shafts may need to be lengthened or trued, and U-joints may need to be replaced.
5. Secure and properly block vehicle prior to installation of BDS Suspension components. Always wear safety glasses when using power tools.
6. If installation is to be performed without a hoist, BDS Suspension Co. recommends rear alterations first.
7. Due to payload options and initial ride height variances, the amount of lift is a base figure. Final ride height dimensions may vary in accordance to original vehicle attitude. Always measure the attitude prior to beginning installation.

POST-INSTALLATION WARNINGS

1. Check all fasteners for proper torque. Check to ensure for adequate clearance between all rotating, mobile, fixed, and heated members. Verify clearance between exhaust and brake lines, fuel lines, fuel tank, floor boards and wiring harness. Check steering gear for clearance. Test and inspect brake system.
2. Perform steering sweep to ensure front brake hoses have adequate slack and do not contact any rotating, mobile or heated members. Inspect rear brake hoses at full extension for adequate slack. Failure to perform hose check/ replacement may result in component failure. Longer replacement hoses, if needed can be purchased from a local parts supplier.
3. Perform head light check and adjustment.
4. Re-torque all fasteners after 500 miles. Always inspect fasteners and components during routine servicing.

PARTS LIST

Part #	Qty	Description			
01178	1	Steering Knuckle- DRV			
01179	1	Steering Knuckle- PASS			
539	1	Bolt Pack			
	2	5/8"-11 x 6" bolt			
	2	5/8"-11 x 5" bolt			
	4	5/8"-11 prevailing torque nut			
	8	5/8" SAE flat washer			
	1	9/16"-12 x 4-1/2" bolt			
	3	9/16"-12 prevailing torque nut			
	6	9/16" SAE flat washer			
	2	9/16"-12 x 1-1/2" bolt			
	5	10mm-1.50 x 60mm bolt			
	5	10mm flat washer			
	2	3/8"-16 standard hex nut			
	2	3/8" SAE flat washer			
	2	3/8" lock washer			
540	1	Bolt Pack			
	3	1/2"-13 x 1-1/4" bolt			
	3	1/2" SAE flat washer			
	12	10mm-1.50 x 70mm bolt			
	12	10mm flat washer			
	6	1/4"-20 x 3/4" bolt			
	6	1/4" SAE flat washer			
	6	1/4" lock washer			
	4	7/16"-14 x 3-1/2" bolt			
	4	7/16"-14 x 1-1/4" bolt			
	4	7/16"-14 prevailing torque nut			
	12	7/16" SAE flat washer			
	6	Wire Clamp			
541	1	Bolt Pack			
	8	7/16"-14 x 1-1/4" bolt			
	8	7/16"-14 prevailing torque nut			
	16	7/16" SAE flat washer			
	4	3/8"-16 x 1-1/2" bolt			
	4	3/8"-16 prevailing torque nut			
	8	3/8" SAE flat washer			
	2	3/8"-16 x 2" bolt			
	2	3/8"-16 prevailing torque nut			
	4	3/8" SAE flat washer			
	1	5/16"-18 x 1" bolt			
	1	5/16"-18 prevailing torque nut			
	2	5/16" USS flat washer			
	1	3/8"-16 x 1" bolt			
	1	3/8"-16 prevailing torque nut			
	2	3/8" USS flat washer			
			556	1	Bolt Pack
				4	5/8" SAE flat washer
				4	5/8"-11 prevailing torque nut
				4	3/8"-16 x 2-1/2" bolt
				4	3/8"-16 prevailing torque nut
				8	3/8" SAE flat washer
			557	1	Bolt Pak
				2	3/8"-16 x 1-1/4" bolt
				4	3/8"-16 x 2-3/4" bolts
				10	3/8" washer
				4	3/8"-16 torque nut
				6	1/2"-13 x 1-1/4" bolt
				12	1/2" washer
				6	1/2"-13 torque nut
				2	9/16"-12 x 3" bolt
				4	9/16" SAE washer
				2	9/16"-12 torque nut
		01180	1	Front Crossmember	
		01181	1	Rear Crossmember	
		M02096-RB	2	Bump Stop	
		01183	2	CV Spacer	
		01184	1	Differential Skid Plate	
		01185	1	Differential Drop Bracket (DRV)	
		01186	1	Differential Drop Bracket (PASS)	
		01187	1	Weld-in Plate	
		01188	2	Compression Strut	
		01189	2	Compression Strut Mount	
		01190	2	Strut Mount Nut Tab	
		02322	2	Torsion Bar Drop Bracket	
		M02016BK	2	Bushings - Hourglass	
		54587	2	3/4" x 0.090 x 1.575 Sleeve	
		01192	1	Carrier Bearing Drop Bracket	
		01196	2	Rear Bump Stop Spacers	
		01661	1	Brake Line Bracket	
		2081BK	8	Bushing	
		32-1	4	5/8" x 0.083" x 2.365" Sleeve	
		BSJRFB	2	Bushing	
		15-1	1	3/4" x 0.083" x 2.955" Sleeve	
		02129	4	U-Bracket	
		911104	2	Sway Bar Link	
		SB58RB	4	Bushing	
		45313	4	Sleeve	
		SBLA	1	Brake Line Bracket	
			2	loctite	

INSTALLATION INSTRUCTIONS

PRE-INSTALLATION MEASUREMENTS

Measure from the center of the wheel up to the bottom edge of the wheel opening

LF _____ RF _____ LR _____ RR _____

FRONT INSTALLATION

1. Park the vehicle on a clean, level surface and block the rear wheels for safety.
2. Safely raise the front of vehicle and support with jack stands for safety.
3. Remove the wheels.
4. Measure and record the length of the exposed thread on the torsion bar adjusting bolts for later reference.
5. DRV _____ PASS _____
6. Remove the torsion bar assembly. CAUTION: The torsion bar is under extreme pressure. Use the correct unloading tool to remove the pressure on the torsion bars before attempting to remove the assembly. A J36202 or equivalent torsion bar unloading tool must be used. Be sure to follow the OE manual and the torsion bar unloading tool literature as to how to unload the torsion bars.
7. Unload the torsion bars, but do not remove.
8. Mark the unloaded torsion bars to indicate passenger's and driver's side. Mark both of the torsion bars to indicate the front versus the rear for later installation. Also mark the torsion bars relative to the control arms at the front to note indexing. Mark the rear of the bars relative to the adjusting arms to indicate indexing.
9. Drive the torsion bars forward using a maul or an air hammer through the access hole in the back of the torsion bar crossmember. Note: This will allow the torsion bar adjusters to drop free.
10. Remove the bolts holding the torsion bar crossmember to the frame. Retain these fasteners with the crossmember after removal. Remove the crossmember. Note: It may be necessary to remove a portion of the exhaust system on some vehicles in order to complete this operation.
11. Remove the torsion bars by pulling them toward the rear of the vehicle.
12. Remove the front OE differential skid plate and front splash shield from the vehicle. These will not be reused.
13. Remove the sway bar end links from the sway bar and lower control arms. Discard the end links.
14. Remove the shocks. Discard the shocks and retain the lower mounting hardware.

15. Disconnect the tie rod ends from the steering knuckles. Remove and retain the mounting nuts. Strike the steering knuckle at the tie rod end to dislodge the end (Fig 1). Take care not to damage the tie rod end.

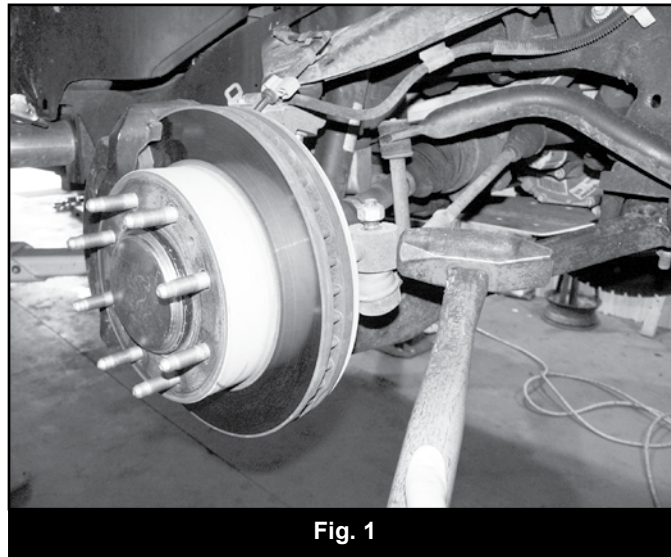

16. Disconnect the ABS brake wire from the frame and the control arm. Remove the brake hose bracket from the steering knuckle (Fig 2).
17. Follow the ABS line up to the frame to find the wire connector. Disconnect the ABS wire and hang it out of the way.
18. Disconnect the brake line bracket from the upper control arm by removing the retaining bolt (Fig 2). Retain the mounting hardware.

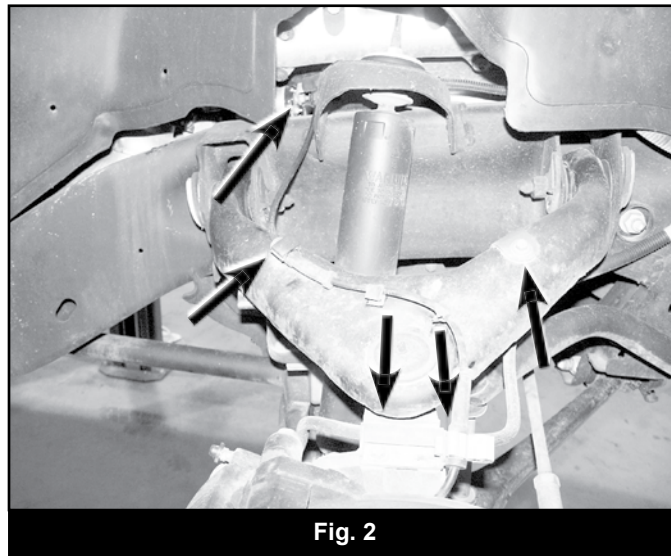

19. Remove the brake caliper anchor bracket bolts and pull the caliper free from the steering knuckle and rotor (Fig 3). Hang the caliper securely out of the way. Retain caliper mounting hardware. Remove the brake rotor from the hub. Note: Do not allow the brake caliper to hang from the brake hose.

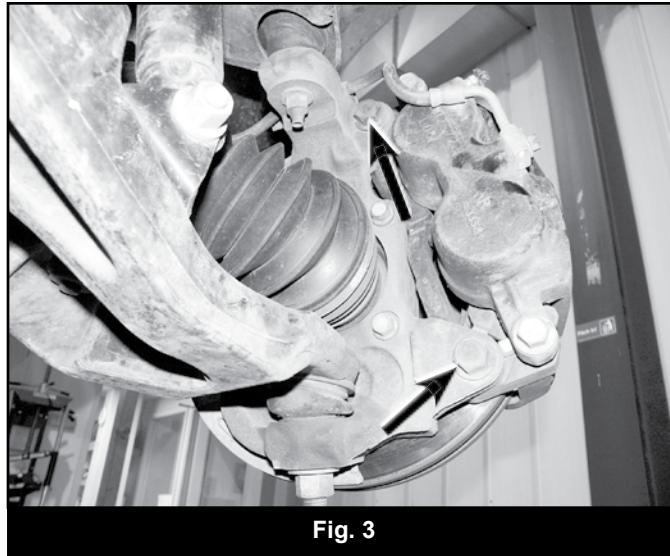

19. Carefully remove the axle hub dust cover, if equipped. (Fig 4). Remove the axle hub nut.

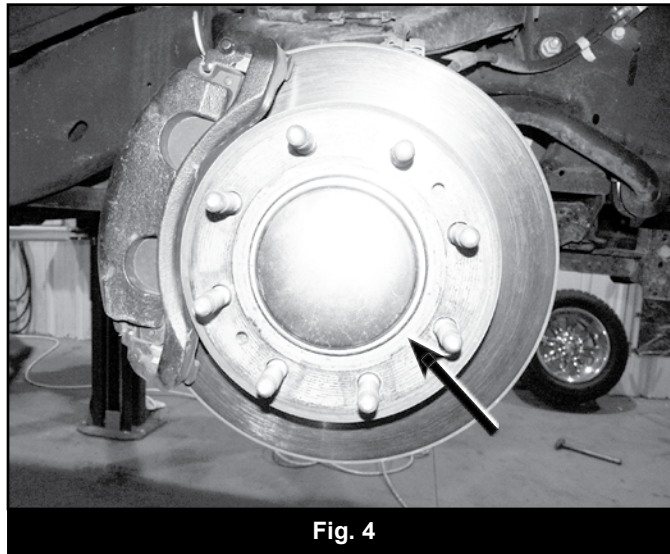

20. Disconnect the CV axles from the differential by removing the mounting flange bolts (Fig 5).

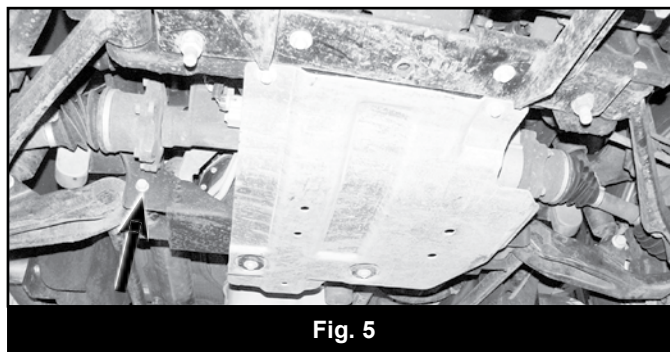

21. Remove the upper and lower ball joint nuts. Reinstall the nuts a few turns by hand. Dislodge the upper and lower ball joints from the steering knuckle by striking the knuckle near each joint with a hammer. Remove the upper ball joint nut and allow the knuckle/CV axle and lower control arm to swing down. Remove the CV axle from hub.
22. Remove the lower ball joint nut and remove the knuckle from the lower control arm. Retain the ball joint nuts.
23. Remove the four bolts mounting the hub bearing assembly to the OE steering knuckle. Retain the mounting bolts. Remove the hub assembly from the knuckle. Note: It may be necessary to press the hub out of the knuckle as a result of excessive corrosion on some vehicles.

24. Carefully remove the large O-ring from the knuckle and retain.
25. Install the large OE hub o-rings in the new knuckles (01178, 01179). Install the corresponding hub and fasten with the stock mounting bolts. Index the hub so that the ABS line runs out the front side of the knuckle under the steering arm. Use loctite on the bolt threads and torque to 125 ft-lbs.

ⓘ *Note: The OE dust shield will not be reused.*

26. Remove the lower control arm pivot bolts and remove the control arm from the vehicle.
27. Remove the OE lower control arm bump stops from the frame.
28. Disconnect the front driveshaft from the differential housing and retain all mounting hardware.
29. Disconnect the vacuum line from the driver's side of the front differential. Disconnect the electrical connector from the differential actuator and remove the wire from the two plastic clamps along the top of the differential (Fig 6, 7).

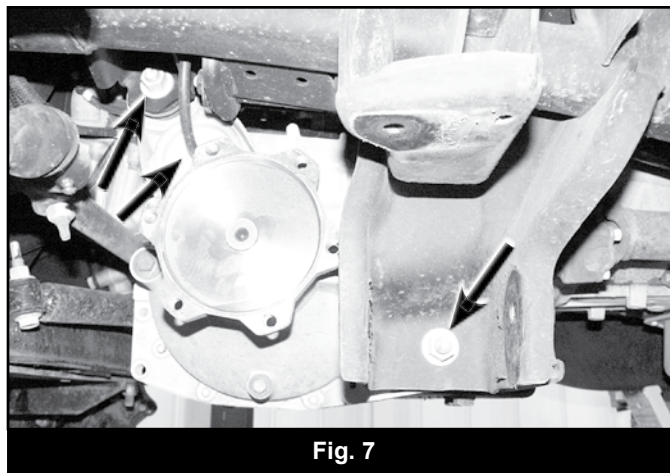
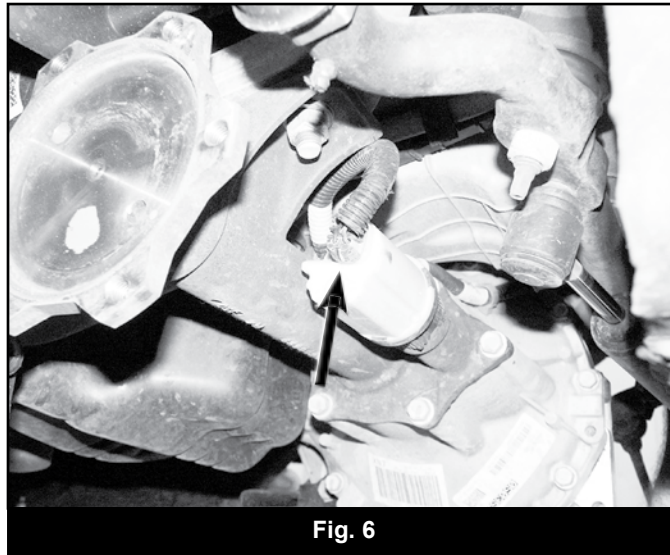

30. Remove the stock rear differential crossmember by removing the two mounting bolts on each side (Fig 8).

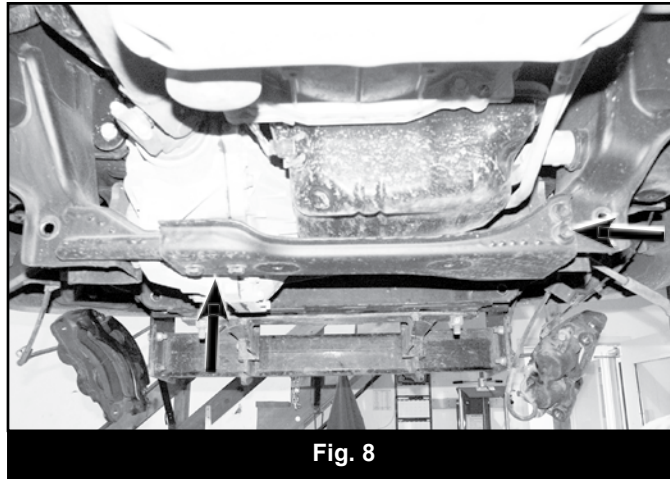

Fig. 8

31. Support the front differential with an appropriate jack and remove the driver's side front and rear mounting bolts as well as the two mounting nuts on the passenger's side (Fig 7, 9). Retain all hardware. To gain additional clearance for removal, pull the steering all the way to the left. Remove the differential from the vehicle. Note: On some diesel equipped vehicles it may be easier to remove the differential if the next step is completed first.

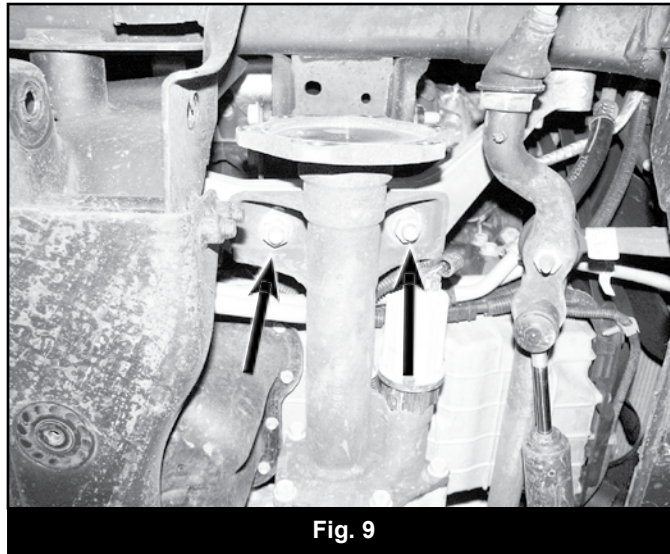

Fig. 9

32. The driver's side rear differential mount must be removed. Measure from the backside of the control arm pocket 1-3/4" and make a vertical cut line around the entire pocket (Fig 10A, 10B). Using a sawzall, die grinder or plasma cutter, remove the differential mount from the frame. Note: Always check for fuel lines and/or electrical wires before cutting. Undercoating is flammable. Keep a fire extinguisher close by for safety.

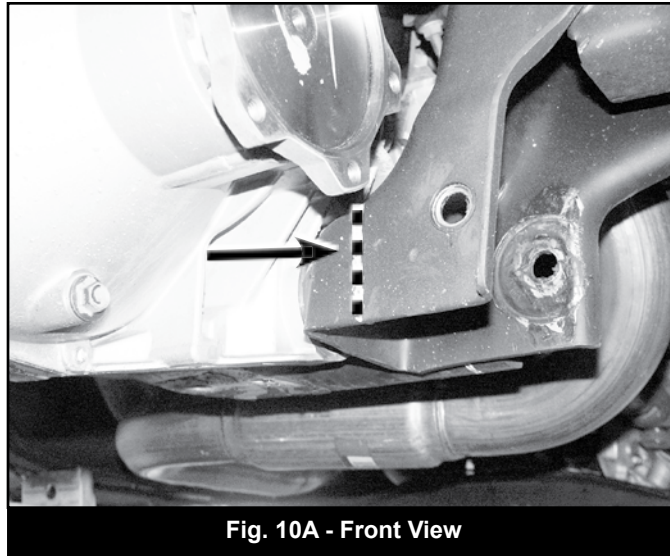

Fig. 10A - Front View

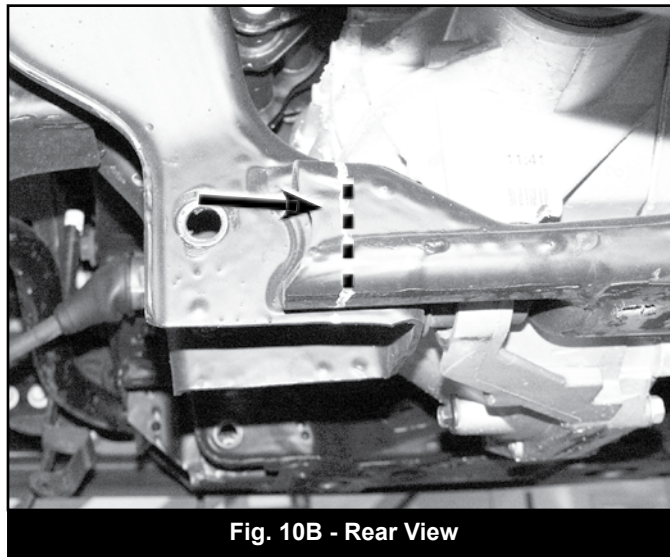

Fig. 10B - Rear View

33. With the back of the control arm pocket removed, clean the area free of paint and grease. Place the provided plate up to the back of the pocket and weld in place. Let the area cool and coat with a rust preventative paint or undercoating. Undercoating is flammable. Keep a fire extinguisher close by for safety. Welding should be performed by a certified welder.
34. The front driver's side differential mounting eye must be removed from the differential (Fig 11). Mark the eye with a cut line smooth to the housing. Using a sawzall, cut the mounting eye off of the housing. Do not cut into the main housing body.



Fig. 11

35. Install the bushings (3624RB) and $\frac{3}{4}$ " x 2.955" sleeve (15-1) in the new differential bracket (01185). Line the bracket up to the differential case bolts to determine which five bolts to remove. Remove the appropriate bolts and install the bracket with five 10mm x 60mm bolts and 10mm flat washers from bolt pack #539 (Fig 12A). Use Loctite on the threads and torque to 30 ft-lbs.

ⓘ *Note: On 2007 models, trim the small boss sticking out from the differential housing between the two lower brackets mounting holes. Trim the boss just enough to clear the bracket so it can mount flush. (Fig 12B)*

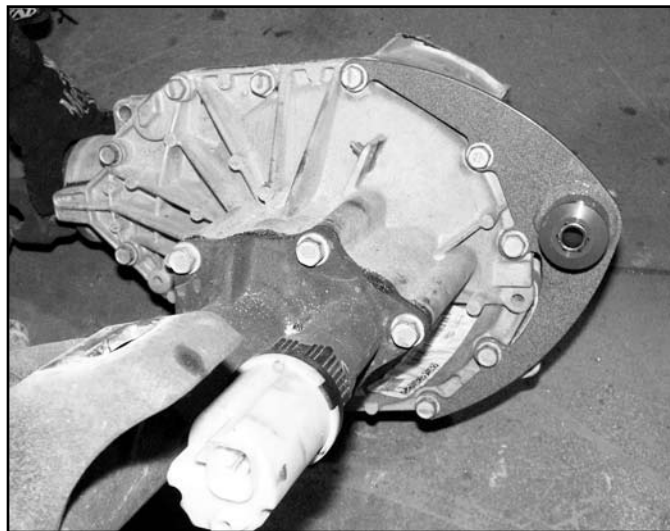

Fig. 12A

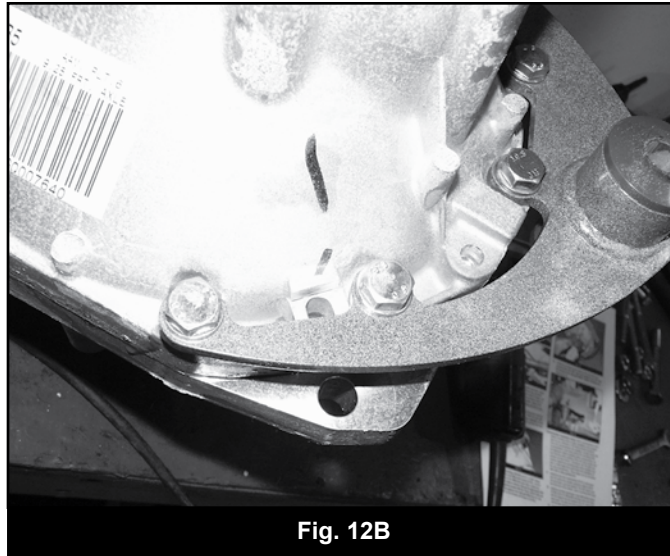

Fig. 12B

36. Install the provided bump stops to the new BDS rear crossmember with 3/8" nuts, lock washers and 3/8" SAE flat washers from bolt pack #539. Tighten hardware securely (Fig 13).

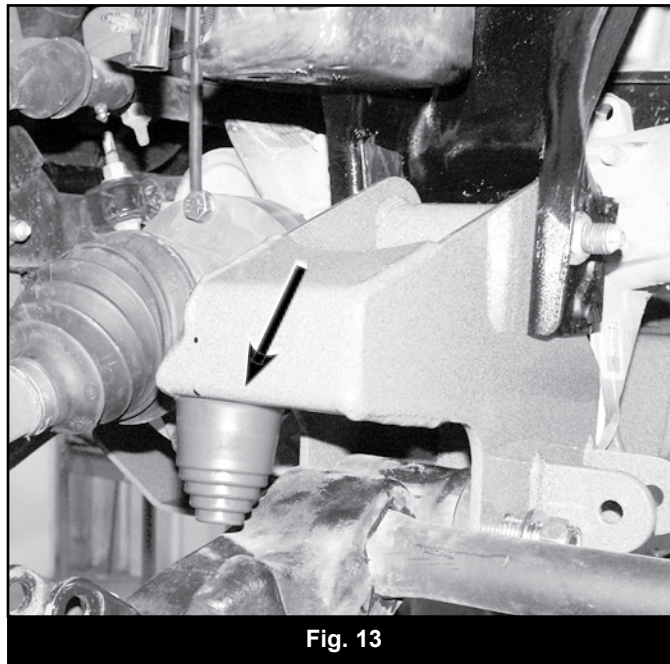

Fig. 13

- ⓘ *Crossmember Installation Notes: BDS crossmembers have slotted mounting holes to ease installation and compensate for any variances in OE frame bracket locations. Once the crossmembers are installed, visually center the crossmembers in the frame before the mounting bolts are tightened. Before installing either crossmember, be sure that the inside surfaces of the OE lower control arm pockets are free of burrs. Commonly, the OE bolts and washers stretch the mounting holes when installed and leave a rolled edge that could hinder the installation of the new crossmembers. These edges can be smoothed with a file or rotary grinding tool.*
37. Install the new rear crossmember (01181) in the lower rear OE control arm pockets using the original control arm pivot bolts, nuts and washers. The bolt heads must be to the front of the vehicle. Leave mounting bolts loose.
 38. Install the provided passenger's side differential bracket (01186) to the OE differential mounting studs and retain with the original nuts and washers (Fig 14). Leave hardware loose. The wide end of the bracket goes to the front and the open side faces inward.
 39. Install the differential in the new rear crossmember and fasten with the OE hardware. Leave hardware loose.
 40. Fasten the passenger's side of the differential to the new bracket with two 9/16" x 1-1/2" bolts, nuts and 9/16" SAE washer from bolt pack #539. Snug hardware.
 41. Install the new front crossmember (01180) in the lower front OE control arm pockets using the original control arm pivot bolts, nuts and washers. When install the crossmember, align the front differential in the tabs on the back of the crossmember (Fig 14). Leave mounting hardware loose.

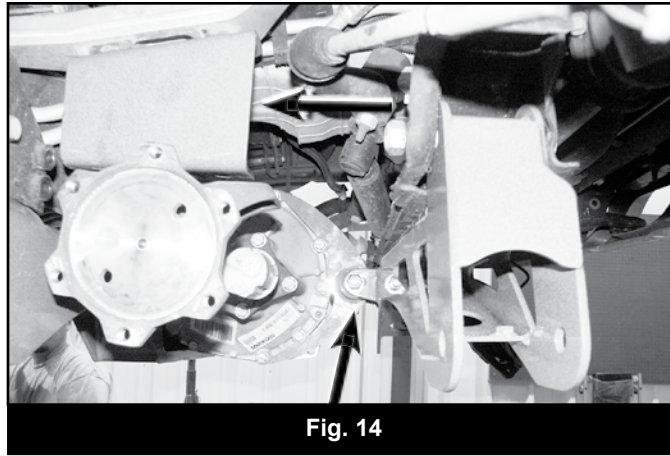

Fig. 14

42. Fasten the front differential mount to the front crossmember with a 9/16" x 4-1/2" bolt, nut and 9/16" SAE washers from bolt pack #539. Leave hardware loose.
43. Reconnect the electrical wires and breather hose to the differential. It may be necessary to gain slack for the breather hose up in the engine compartment.
44. Install the new differential skid plate (01184) to the welded nuts on the front and rear crossmembers with 1/2" x 1-1/4" bolts and 1/2" SAE washers from bolt pack #540 (Fig 15). Use loctite on the bolt threads. Leave hardware loose.
45. Install the OE lower control arms in the front and rear crossmembers with 5/8" x 5" bolts (front), 5/8" x 6" bolts (rear), nuts and 5/8" SAE washers from bolt pack #539. Leave hardware loose. The heads of the bolts must be to the front of the vehicle.
46. Tighten the following hardware:
 - Front and rear crossmember pocket bolts to 100 ft-lbs
 - Driver's side differential bolts to 70 ft-lbs
 - Passenger's side differential bolts and nuts to 70 ft-lbs
 - Differential skid plate bolts to 50 ft-lbs.

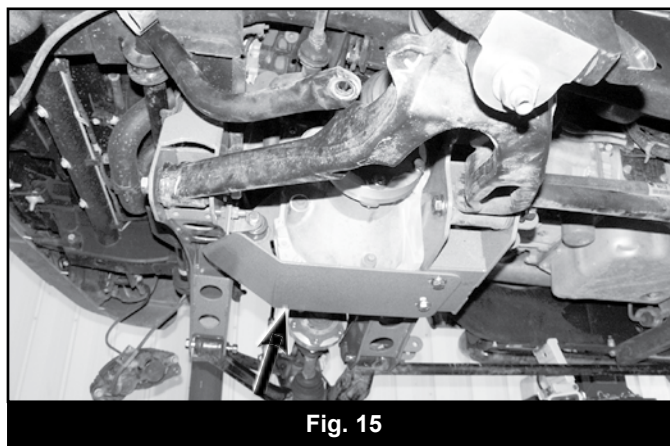

Fig. 15

47. Attach the new knuckle assembly to the upper and lower ball joints and fasten with the OE nuts. Torque the upper ball joint to 37 ft-lbs and the lower to 74 ft-lbs.
48. Rotate the steering tie rod 180° and install it in the new knuckle steering arm from the top down. Fasten with the OE nut and torque to 30 ft-lbs.
49. Install the CV axles in the hubs and fasten with the OE axle nut. Be sure that the axle is fully seated in the hub and torque the axle nut to 155 ft-lbs. Install the axle nut cover if equipped.
50. Install the provided CV shaft spacers (01183) between the CV shaft and the differential. Fasten the CV shaft and spacers to the differential with 10mm x 70mm bolts and 10mm flat washers from bolt pack #540 (Fig 16). Use loctite on the bolt threads and torque them to 58 ft-lbs in a crossing pattern.

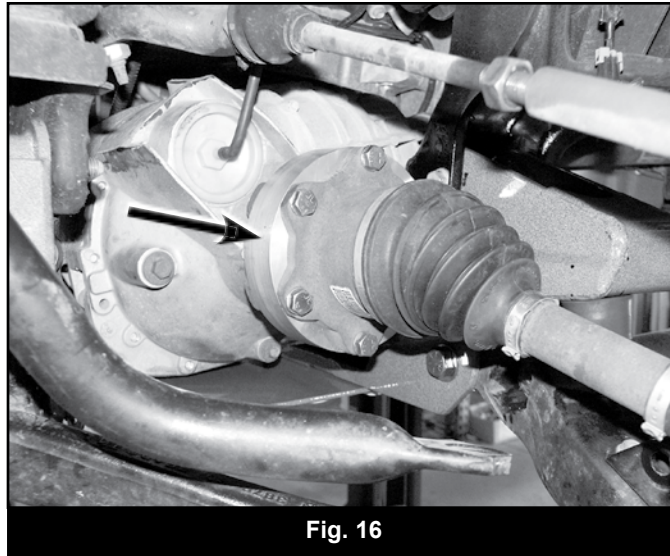

Fig. 16

51. Install the brake rotor on the hub then install the brake caliper on the rotor/knuckle and fasten with the OE mounting bolts. Torque the caliper bolts to 70 ft-lbs. Be sure that the brake hose is routed behind the knuckle and under the upper control arm. Use Loctite® on caliper hardware.
52. Attach the brake hose to the upper control arm in the original location with the stock hardware. Attach the hose to the steering knuckle in the holes provide with a ¼" x ¾" bolt, ¼" SAE flat washer and ¼" lock washer from bolt pack #540. Torque to 10 ft-lbs. Note: The OE brake hose brackets can be spread open and slid along the hose as necessary.
53. Attach the ABS line to the front side of the knuckle with the provided wire clamps and ¼" x ¾" bolts, ¼" SAE flat washers and ¼" lock washers from bolt pack #540. Torque to 10 ft-lbs. Attach the ABS wire to the upper control arm with the provided wire ties and reconnect the wire connector at the frame. (Fig 17)

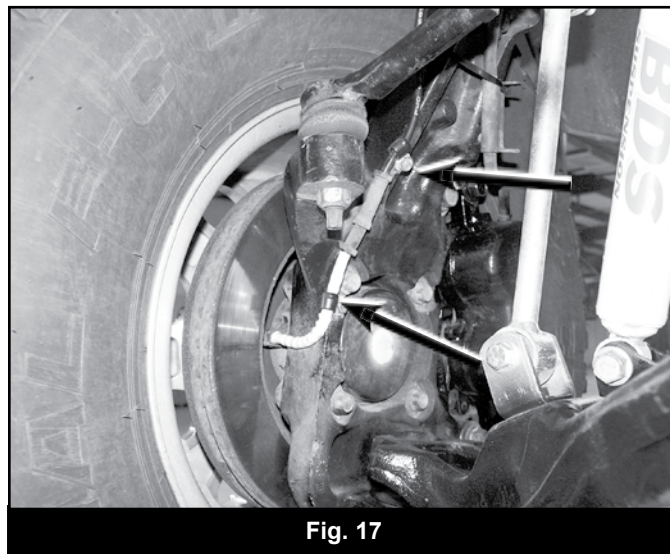
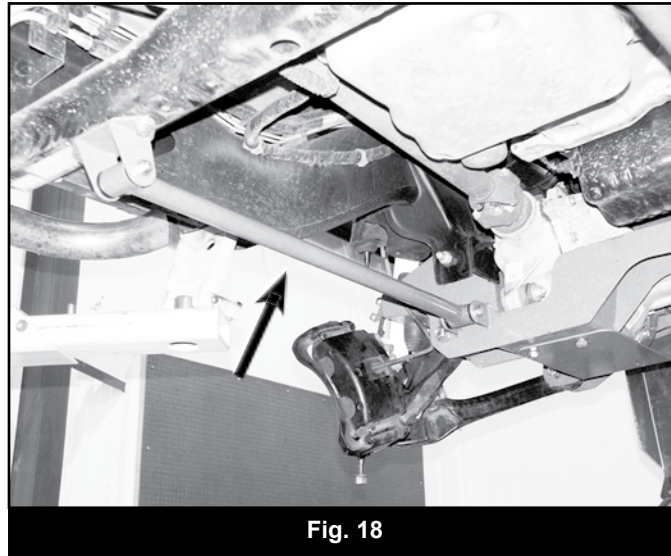

Fig. 17

54. Double check brake hoses and ABS wires for clearance of all moving objects. Do a steering sweep to check for clearances.
55. Install the new BDS shocks with the new upper hardware in conjunction with the OE lower mounting hardware. Torque the lower bolt to 35 ft-lbs and tighten the upper nuts until the bushings begin to swell.
56. Loosely install the provided sway bar link u-brackets (02129) to the link mounting holes in the sway bar and lower control arm with 5/8" bolts, nuts, and SAE washers from bolt pack #556. The SAE washers will mount on the head of the bolt inside of the u-bracket.
57. Install the provided hourglass bushings (3624RB) and sleeves (45313) in the eyes of the new sway bar end links (911104). Install the links in the u-bracket mounted on the lower control arms and sway bar. The links should be mounted so that the u-shape of all the brackets can be seen from the side of the vehicle. Retain the links in the brackets with 3/8" x 2-1/2" bolts, nuts and 3/8" SAE washers from bolt pack #556.

58. With the links completely installed, tighten the 3/8 hardware to 30 ft-lbs and the 7/16" hardware to 40 ft-lbs.
59. Attach the driveshaft to the differential with the original mounting hardware and torque to 19 ft-lbs.
60. Install the bushings (2081BK) and sleeves (32-1) in the new compression struts (01188). Attach the struts to the mounting tabs on the back of the rear crossmember with 7/16" x 3-1/2" bolts, nuts and 7/16" SAE flat washers from bolt pack #540. Leave hardware loose.
61. Swing a compression strut up to the rear crossmember to help determine the positioning of the rear mounting bracket. With Allison transmissions the hole in the mounting tab should be closer to the front (Fig 18- Allison Transmission Shown). On other transmissions the hole will be closer to the rear.



62. After the position is determined, install the rear mounting bracket (01189) to the compression strut and swing it up to the transmission crossmember again. Ensure that the two mounting holes in the bracket are relatively centered on the crossmember and using the bracket as a template, mark the holes on the crossmember for drilling. Note: If the bracket is not lining up on the crossmember correctly, turn the bracket around on the strut. Some vehicles may have a transfer case skid plate mounting off of the transmission crossmember that may interfere with the rear strut mount. If this is the case remove the skid plate. It can either be modified to clear the new mount or left off.
63. Drill 7/16" holes at the marks on the transmission crossmember through the first layer of metal only.
64. Install the compression strut nut tab (01190) in the transmission crossmember and line the nuts up with the holes just drilled. Attach the compression strut mount to the crossmember with 7/16" x 1-1/4" bolts and 7/16" SAE flat washers from bolt pack #540. Use Loctite® on bolt threads. Torque bolts to 35 ft-lbs.
65. Install the driver's and passenger's side torsion bars in the front lower control arms using the index marks made earlier. Slide the bars forward about one foot.
66. Locate the provided torsion bar drop brackets, large hourglass bushings and (2) 0.750" OD x 1.575" long sleeves. Install the bushings and sleeves in the brackets.
67. Install the new torsion bar bracket on the frame by attaching the upper tabs to the original mount on the frame. Loosely position with a provided 9/16" x 3" bolt (Pack 577). Position the bracket so it is flush to the bottom of the frame and the 9/16" bolt is centered in the slotted holes in the brackets then mark the center of the lower slotted holes to be drilled (Figure 19). With the hole positions marked, remove the bracket and drill the two new 1/2" holes at the marks.



Fig. 19

68. With the new holes drilled, reinstall the new torsion bar brackets on the frame with the provided 9/16" x 3" bolts, nuts, and washers through the factory mounts. Install 1/2" x 1-1/4" bolts, nuts and washers (from pack #577) through the bracket and newly drilled holes (Figure 20). Leave all hardware loose.
69. Attach the factory torsion bar crossmember to the new drop brackets and fasten with the original bolts (Figure 41). Be sure the large torsion bar holes in the crossmember are toward the front. Torque factory bolts to 90 ft-lbs.

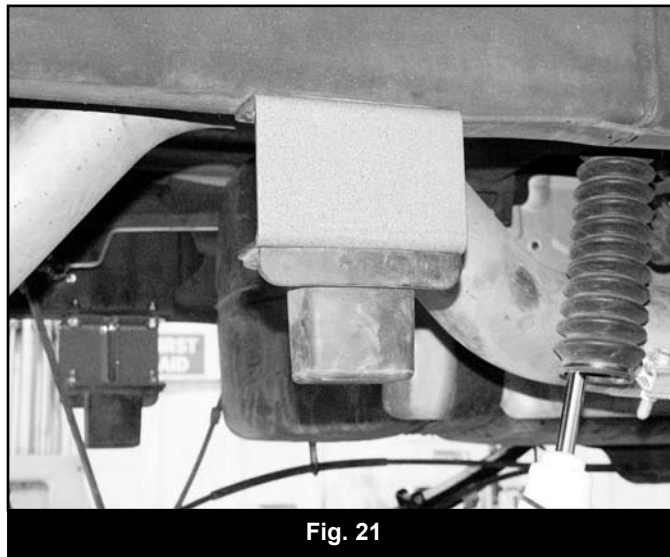

Fig. 20

70. Go back and tighten the torsion bar drop bracket hardware, starting with the 1/2" (60 ft-lbs) followed by the 9/16" (95 ft-lbs).
- ⓘ *Note: The 3/8" hardware in pack #577 will not be used for this application.*
71. Install the torsion bar crossmember to the new drop bracket with the OE hardware and torque to 60 ft-lbs.
 72. Install the driver's and passenger's torsion bars into the adjusters and crossmember using the index marks made earlier. Load the torsion bars with the appropriate tools and set adjuster bolts to the measurements made before disassembly. Do not adjust the torsion bars higher than 30" from the bottom of the fender to the center of the front hub with the vehicle setting on flat ground.
 73. Install the front wheels and torque the lug nuts to the appropriate specifications. Spin the wheels and do a steering sweep to check for any binding or clearance issues.
 74. Lower the vehicle to the ground and bounce it to settle the suspension. Torque the lower control arm bolts to 125 ft-lbs.
 75. Double check all fasteners.

REAR INSTALLATION

76. Raise the rear of the vehicle and support the frame with jack stands just ahead of the spring hangers.
77. Remove the wheels.
78. Support the rear axle with a hydraulic jack under the differential and remove the OE shocks. Retain hardware.
79. Disconnect the brake line junction block from the differential by removing the differential cover bolt.
80. Install the provided brake line extension bracket to the original differential mounting location with the OE fastener and tighten securely.
81. Disconnect the emergency brake cable retainers from the driver's side frame rail. Retain all parts and hardware.
82. Disconnect the OE bump stops from the frame and retain the mounting nuts.
83. Install the provided bump stop brackets (01196) to the original bump stop mounting holes in the frame with 3/8" x 1-1/2" bolts, nuts and 3/8" SAE washers. Torque hardware to 30 ft-lbs. The open end of the bracket should face in and the end with three holes should face down.
84. Install the OE bump stop to the relocation brackets with the OE nuts and torque to 30 ft-lbs. Note: The bump stops have a locating tab that will fit into the middle hole in the relocation bracket (Fig 21).



85. While supporting the axle with a floor jack, remove the passenger's side u-bolts. Lower the axle from the spring.

Lift Block Installation

86. Lower the axle from the spring enough to install the 5" block. The short end of the block goes toward the front of the vehicle. Take care not to over-extend any brake lines.

 *Note: It may be necessary to loosen the driver's side u-bolts to allow the axle to drop away from the passenger's side spring.*

87. Align the pins/holes in the block, axle and spring and raise the axle. Install the provide u-bolts, nuts and washers and snug them to the axle. Final torque of the u-bolts will be done with the weight of the vehicle on the axle.
88. Repeat on driver's side of the vehicle.

Spring Installation

89. Lower the axle from the spring. Remove the front spring hanger bolt and rear spring shackle-to-frame bolt and remove the spring from the vehicle.
90. Install the provide bushings and sleeves in the new BDS spring.
91. Remove the shackle from the OE spring and loosely install it on the corresponding end of the BDS spring.
92. Install the new spring in the vehicle with the OE mounting bolts and leave bolts loose.
93. Align the spring pin and the axle perch hole and raise the axle. Install the provided u-bolts and snug them to the axle. Final torque of the u-bolts will be done with the weight of the vehicle on the axle.

94. Repeat on driver's side of the vehicle. Note: The fuel tank may need to be moved to allow removal of the front hanger bolts.

Spring and Block Applications

95. Install the provided BDS shocks with the OE hardware.
96. Attach the brake junction block to the relocation bracket on differential with 5/16" x 1" bolt, nut and 5/16" USS washers from bolt pack #541 (Fig 22). Note: If more brake line slack is needed, the OE brake line bracket at the frame can be disconnected and relocated.

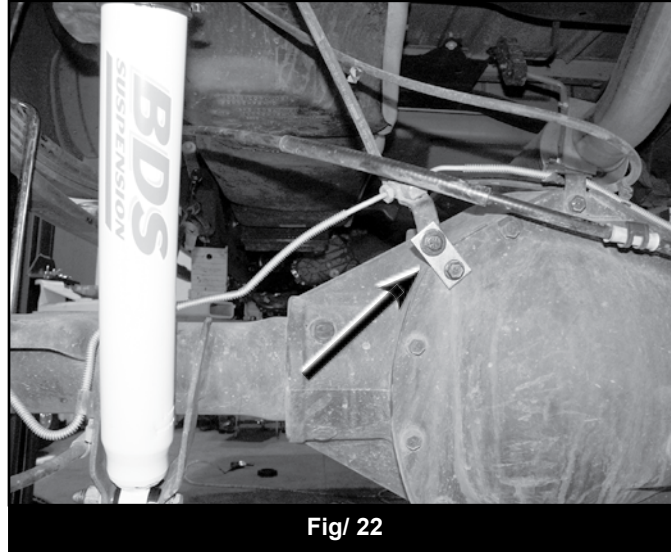

97. Install the provided 3" long brake line relocation bracket to the forward most emergency brake retainer mount with the OE hardware (Fig 23). Install the OE retainer to the bracket with a 3/8" x 1" bolt, nut and 3/8" USS washers.

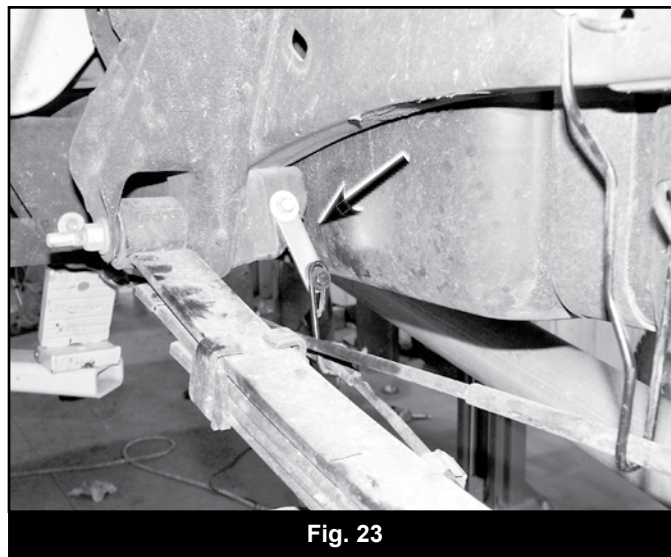

98. Install the rear retainer to the frame in the original hole. The lower emergency bracket line will need to be removed from the rear retainer.
99. If the vehicle is equipped with a two-piece driveshaft the carrier bearing must be relocated. Disconnect the carrier bearing mount from the frame crossmember.
100. Remove the OE studs from the bracket.
101. Install the provided carrier bearing drop bracket with 3/8" x 2" bolts, nuts and thru-hardened 3/8" SAE washers. Torque bolts to 30 ft-lbs.
102. Install the wheels and lower the vehicle to the ground.
103. Bounce the vehicle to settle the suspension and torque the u-bolts to 100-120 ft-lbs.

- 104. If the springs were replaced, torque the shackle and hanger bolts to 70 ft-lbs.
- 105. Double check all hardware.
- 106. Check all fasteners after 500 miles.
- 107. Adjust headlights.
- 108. A front end alignment must be performed.

NOTICE TO DEALER/INSTALLER

These instructions, the warning card, and included decals must be given to the owner of this BDS Suspension product.

For questions, technical support and warranty issues relating to this BDS Suspension product, please contact your distributor/installer before contacting BDS Suspension directly.

Sold/Installed by:

Shock Absorber Installation Instructions



READ AND UNDERSTAND ALL INSTRUCTIONS AND WARNINGS PRIOR TO INSTALLATION OF SYSTEM AND OPERATION OF VEHICLE.

LIMITED LIFETIME WARRANTY

BDS Suspension Co. warrants to the original retail purchaser that its shock and stabilizer cylinders are free from defects in material and workmanship for so long as they own the vehicle. Excluded from this warranty are the finish of the product and mounting bushings. Defects in material and workmanship do not include such things as dented cylinders or bent rods caused by obvious side impact, rust, worn or deformed bushings. A shock absorber is a wear item and over time will experience diminished damping resistance due to normal component wear. This is not a defect in material or workmanship and is therefore not warrantable.

BDS Suspension's obligation under all warranties is limited to the repair or replacement, at BDS's option, of the defective material. Any cost of removal, installation or reinstallation, freight charges, incidental or consequential damages are expressly excluded from these warranties.

INSTALLATION INSTRUCTIONS

1. **Note: Please read instructions thoroughly before installing shock absorber.**
2. Remove old shock absorber from vehicle. Note any spacers, washers, sleeves or other hardware and note their location. Compare the existing hardware with the supplied hardware. Always use new hardware wherever possible. Due to the variety of applications, you may not use any or all of the hardware supplied. You may need to use some of the original hardware. If any of the original hardware is damaged, corroded, bent or broken it must be replaced.

3. If installing dust boot, do so at this time. **Note: The use of a lubricant like dish soap on the inside of the boot will ease installation.** Make sure the washer at the top of the shock is fully seated in the boot all the way around. Secure the bottom of the boot to the cylinder with a plastic tie strap.
4. Install any required bushings and sleeves in to the shock eyes at this time. Install the shock absorber on the vehicle. Use the appropriate illustration as a frame of reference. Due to the different shock mounts within a vehicle model range, the shock eyes must be built to match the shocks that you removed by using the universal hardware kit included. Choose the sleeve with an I.D. closest to the O.D. of the mounting stud or bolt without binding. Some applications will require some extra effort to install.
5. Check all fasteners for tightness before driving and inspect periodically.

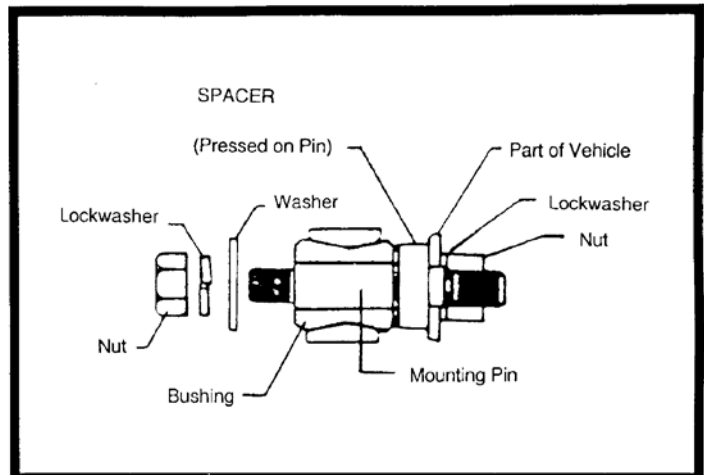

102 S. Michigan Avenue • Coldwater, MI 49036
517-279-2135 • www.bds-suspension.com

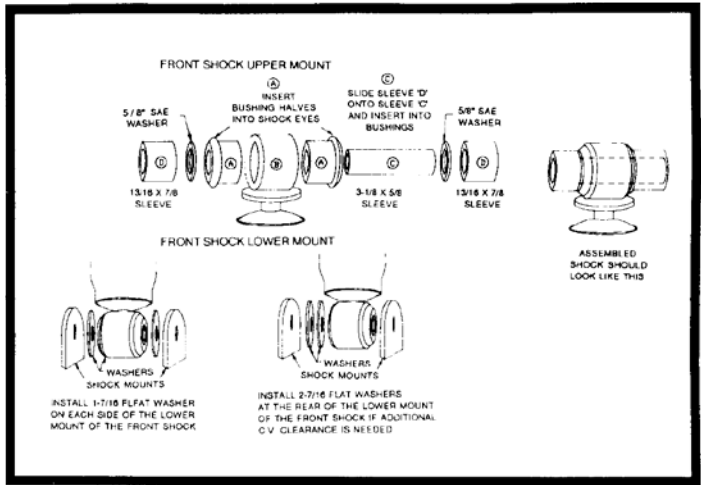
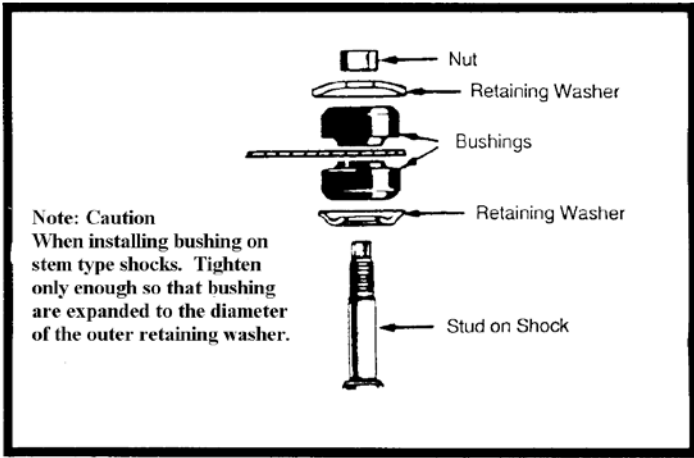

CHEV. S-SERIES W/LIFT

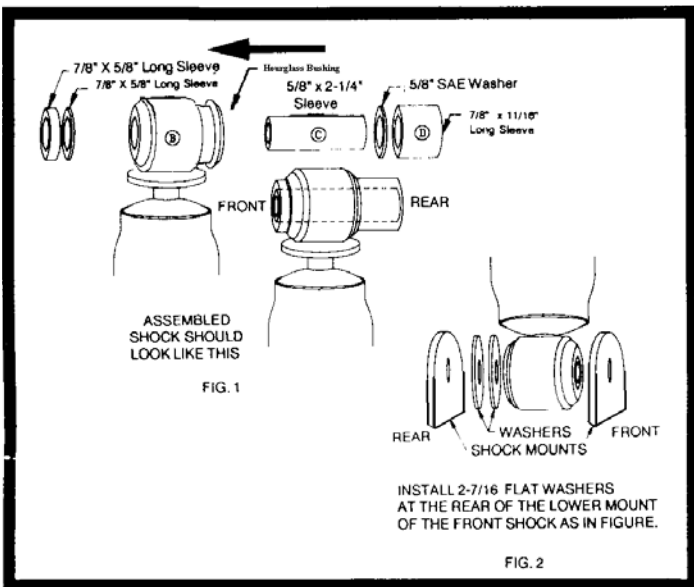
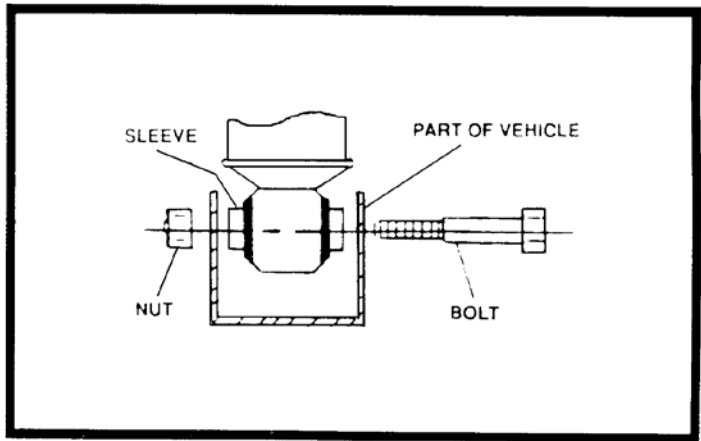
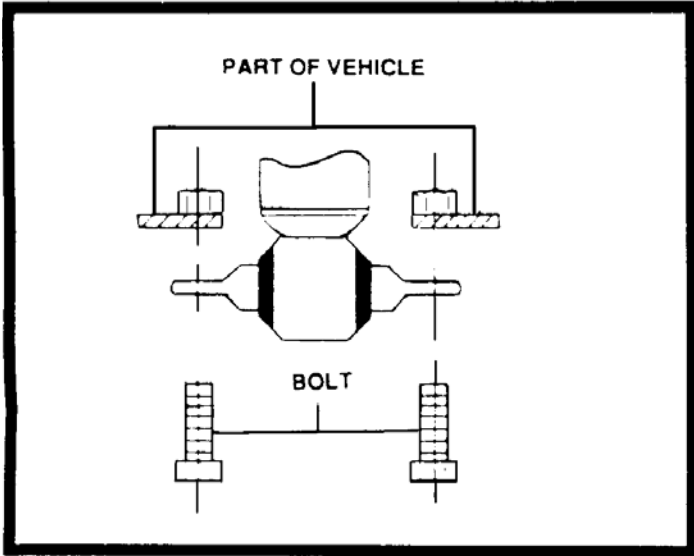

FULL-SIZE CHEV. W/LIFT 88-UP MODELS

